



Touch 5 User & Installation Manual

v2.0



Copyright

This document is copyright 2016 under the Creative Commons agreement. Rights are granted to research and reproduce elements of this document for non-commercial purposes on the condition that CZone is credited as the source. Electronic re-distribution of the document in any format is restricted, to maintain quality and version control.

Important

CZone strives to ensure all information is correct at the time of printing. However, the company reserves the right to change without notice any features and specifications of either its products or associated documentation.

Translations: In the event that there is a difference between a translation of this manual and the English version, the English version should be considered the official version.

It is the owner's sole responsibility to install and operate the device in a manner that will not cause accidents, personal injury or property damage.

Table of Contents

1	GENERAL INFORMATION	4
1.1	Description	4
1.2	Overview	4
1.2.1	Front Controls	4
1.2.2	Rear Connections	4
1.2.3	In The Box	5
1.2.4	Card Reader	5
2	INSTALLATION	6
2.1	Mounting Location	6
2.2	Panel Mounting	6
2.3	Wiring	6
2.4	Power Control Connection	7
2.4.1	Power Control Unconnected	7
2.4.2	Power Control To Supply Positive (Auto On)	7
2.5	NMEA 2000 Backbone	7
3	GETTING STARTED	8
3.1	First Power Up	8
4	OPERATIONS IN DETAIL	10
4.1	Accessing a Function within its Group	10
4.2	CZone Favourites Pages	12
4.3	CZone Functions by Group	13
4.3.1	Modes	13
4.3.2	Controls	15
4.3.3	Monitoring	17
4.3.3.1	DC Monitoring	18
4.3.3.2	AC Mains	19
4.3.3.3	Tanks	20
4.3.4	Alarms	21
4.3.4.1	Alarm Activated	21
4.3.4.2	Alarms of a Selected Severity	21
4.3.4.3	Alarm Page	22
4.3.4.4	Alarm History	23
4.3.5	Settings	24
4.3.5.1	Settings Menu	24
4.3.5.2	Settings screens	25
4.3.5.3	CZone Network status	26
4.4	Updating Software	27
4.4.1	Checking Current Software Version	27
4.4.2	Updating Software via microSD	27
4.5	Connecting iPad to Touch 5	28
5	SPECIFICATIONS	30
5.1	Technical Specifications	30
5.2	Dimensions	30
6	EC DECLARATION OF CONFORMITY	31

1 General Information

1.1 Description

The CZone Touch 5 is a 5" colour touch-screen, which operates as a Display Interface on any new or existing CZone network. It is designed for a wide range of applications, and can withstand the harsh marine and recreational vehicle environments. With its bright touch screen and multiple levels of backlighting, the Touch 5 provides fast and positive operation in all visibility conditions. Together with toughened glass and water proofing, this makes it suitable for exposed locations. The Touch 5 can also be configured as a Wireless Interface, allowing wireless control and monitoring with the CZone iPad App.

1.2 Overview

1.2.1 Front Controls

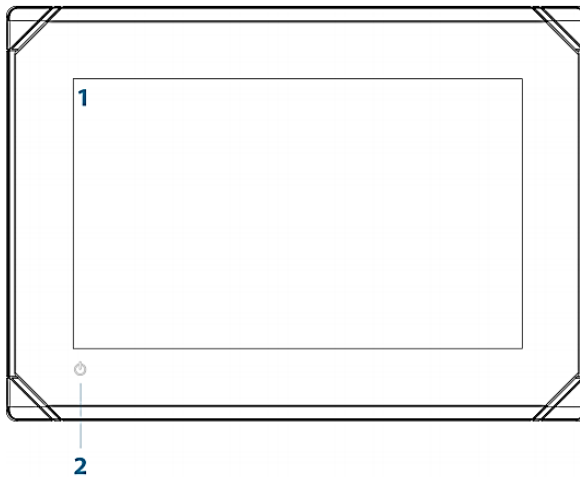

1. Touch Screen
2. Power Button – Press and hold to turn the unit ON

1.2.2 Rear Connections

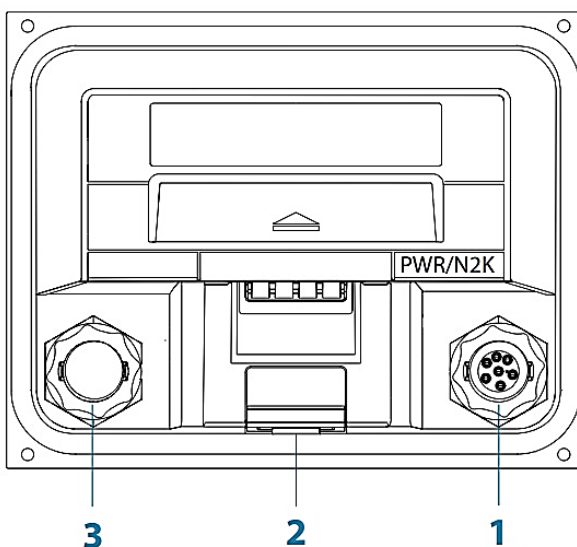

1. 12VDC Power and NMEA 2000
2. MicroSD Card Reader
3. Unused

1.2.3 In The Box

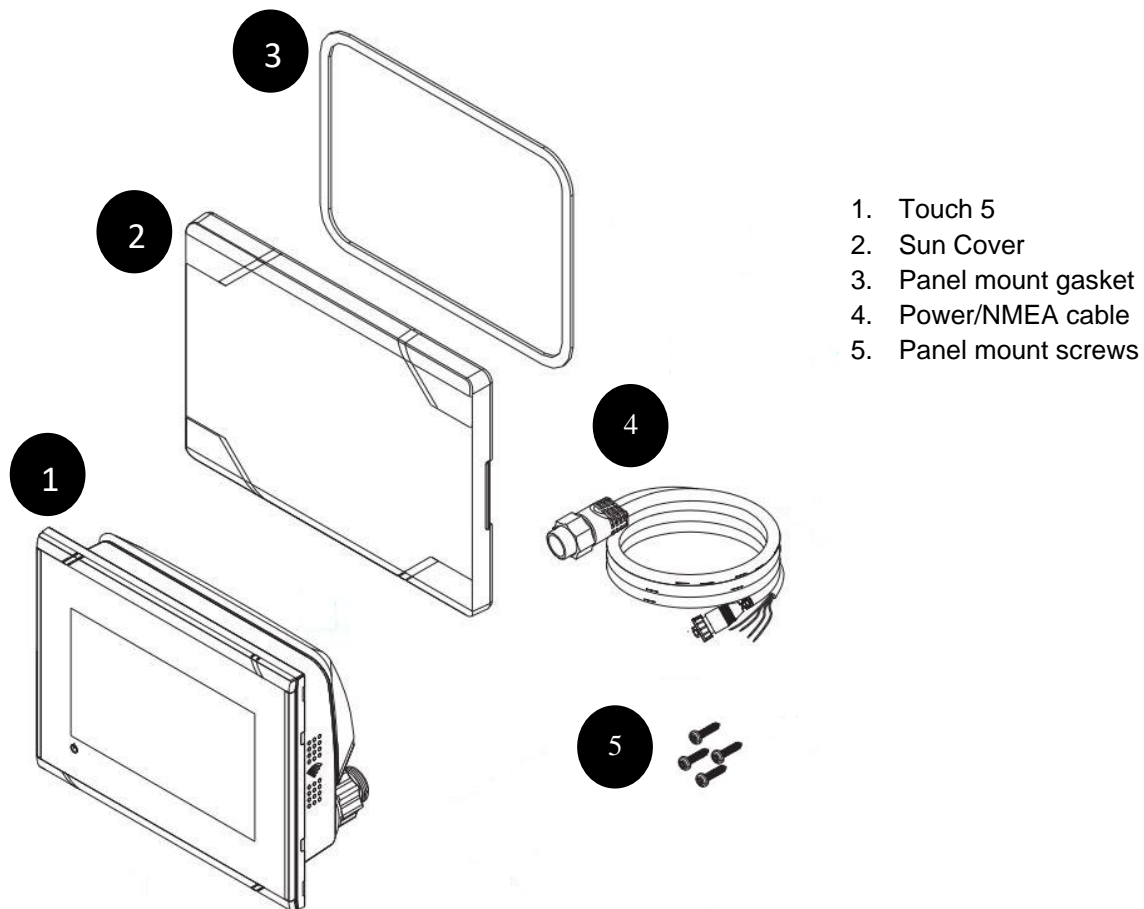

1.2.4 Card Reader

Used for attaching a microSD memory card. The memory card can be used for software updates. The card reader door is opened by pulling the rubber cover open. The card reader door should always be securely shut immediately after inserting or removing a card, in order to prevent possible water ingress.

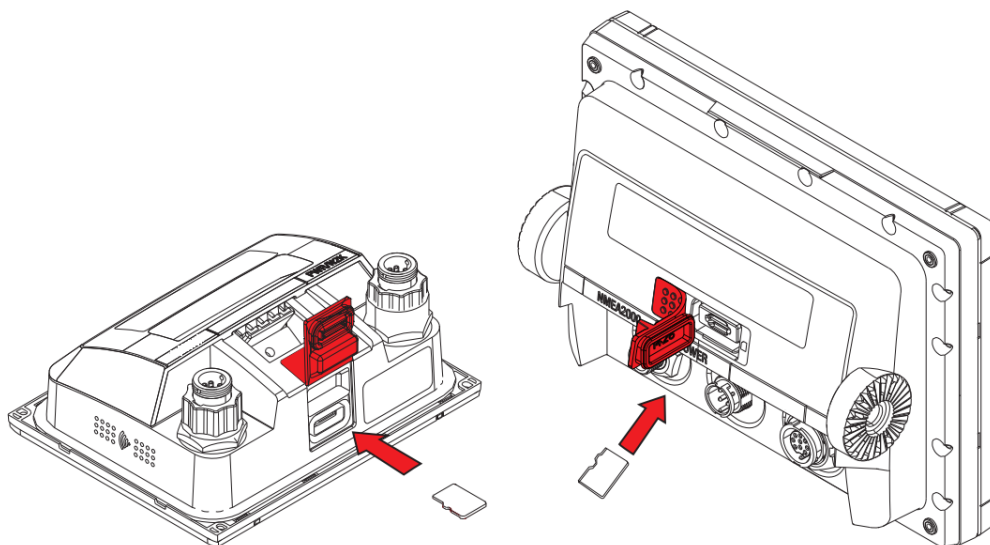

2 Installation

2.1 Mounting Location

Choose the mounting locations carefully before you drill or cut. The unit should be mounted so that the operator can easily use the controls and clearly see the screen. Be sure to leave a direct path for all of the cables. The unit has a high-contrast screen, and is viewable in direct sunlight, but for best results install the unit out of direct sunlight. The chosen location should have minimal glare from windows or bright objects. Choose an area where the unit will not be subjected to excessive vibration, or heat. Good ventilation is required.

Warning! Inadequate ventilation may cause the unit to overheat. The unit is designed to operate in temperatures from -15° C to +55° C (+5° F to +131° F).

2.2 Panel Mounting

The screws and gasket used for panel mounting are included in the box. For mounting instructions, refer to the Panel mounting template.

2.3 Wiring

Warning! Before starting the installation, be sure to turn electrical power off. If power is left on or turned on during the installation, fire, electrical shock, or other serious injury may occur. Be sure that the voltage of the power supply is compatible with the unit.

Warning! The unit has a voltage rating of 12 V DC, it is not suited for use with 24 V DC systems.

The unit is powered by 12 V DC. It is protected against reverse polarity, under voltage, and over voltage (for a limited duration). The plug of the supplied power cable has two discrete cables exiting from it. The thickest of the two cables provides the following:

- Power into the system (Red and Black wires).
- Controlling power state of the unit (Yellow wire)

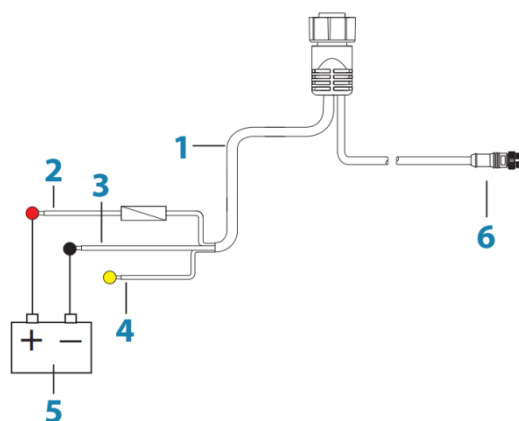

Figure 1. Battery & Power Connections

1. Power cable
2. 12 V DC positive wire (red) shown with fuse holder fitted
3. 12 V DC negative wire (black)
4. Power control wire (yellow)

5. 12 V DC supply
6. NMEA 2000 cable and connector

Connect Red to (+) DC using a 3-amp fuse. Connect Black to (-) DC.

2.4 Power Control Connection

The yellow Power Control wire in the power cable is an input that will turn on the unit when power is applied.

2.4.1 Power Control Unconnected

Device will turn on when the power button on the front of the unit is pressed. Leave the yellow Power Control wire disconnected and tape or heat-shrink the end to prevent shorting.

2.4.2 Power Control To Supply Positive (Auto On)

Device will turn on immediately when power is applied. Common the yellow wire with the red wire after the fuse.

2.5 NMEA 2000 Backbone

Run an NMEA2000 cable from the NMEA2000 connector to an NMEA2000 network backbone

3 Getting Started

3.1 First Power Up

If connecting Touch 5 to an existing CZone network, ensure the display has been added to the CZone configuration file and assigned a dipswitch. Every CZone device on a network requires a unique dipswitch to operate correctly, and the Touch 5 has a virtual dipswitch. Refer to the CZone Configuration Tool manual for this process.

1. Turn on the circuit breaker or switch supplying power to the Touch 5.
2. The CZone splash-screen will appear for about 10 seconds then the text 'Starting Configuration Claim'. Touch 5 will now read the CZone configuration file from the network.
3. When configuration has been successfully read the text 'Configuration Successful' will appear. It is also possible to write the configuration to the network at a later date for new installations.
4. Select the virtual dipswitch from the list of configured CZone devices. For new installations, the dipswitch can be set by selecting Dipswitch from the Settings > System page.



5. If Favourites pages have been pre-installed then they will be shown.

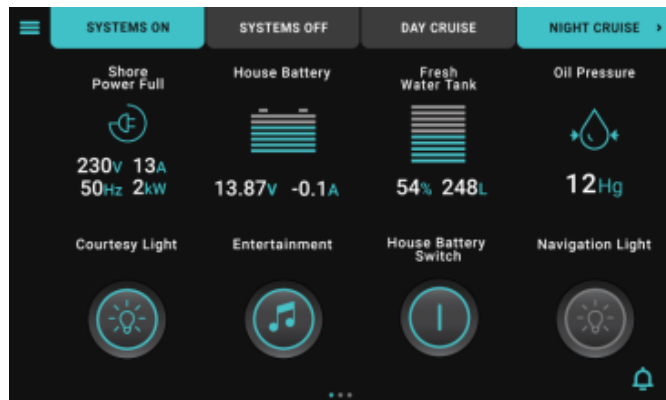

6. In a new installation without Favourites configuration, the display will boot in to the Modes page as shown.

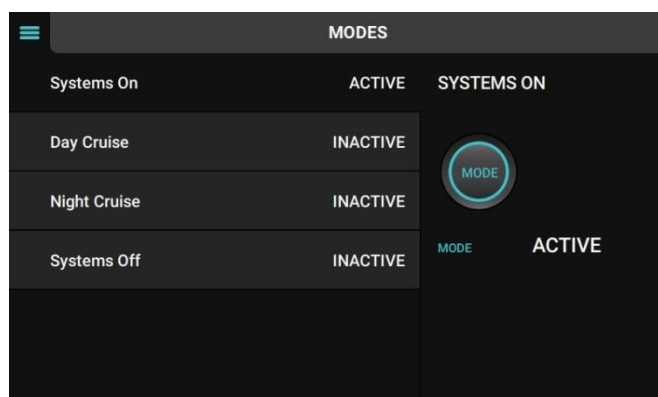

7. To ensure network connections are good and that the display can see the rest of the CZone devices, go to the Settings > Network page and check configured modules are showing 'Online'.

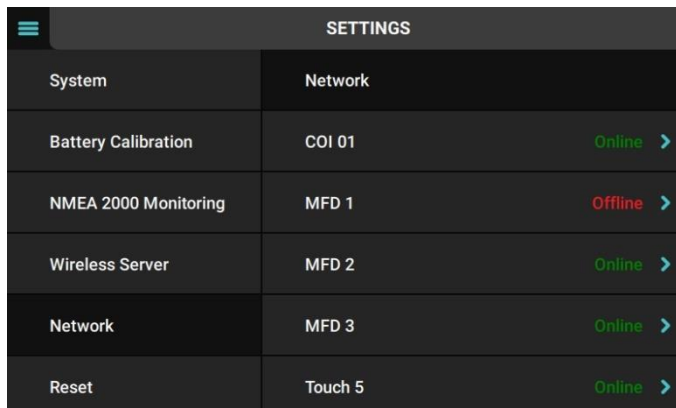

SETTINGS	
System	Network
Battery Calibration	COI 01 Online >
NMEA 2000 Monitoring	MFD 1 Offline >
Wireless Server	MFD 2 Online >
Network	MFD 3 Online >
Reset	Touch 5 Online >

8. If all items are online, Touch 5 is now ready for use.
-

4 Operations in Detail

4.1 Accessing a Function within its Group

CZone operations are divided into six functional groups, each with their own slide-out menu page:

1. **Favourites** – pre-configured pages showing favourite modes, controls and monitoring items
2. **Modes** - complete setups for operating the vessel in a consistent way: for example, when docked; cruising at night or in daylight; at anchor; and so on
3. **Control** - individual control of the vessel's equipment, such as pumps, lights, and power isolators
4. **Monitoring** - measurement of the vessel's devices and subsystems, including tank levels, AC and DC power sources such as batteries and inverters, alarms and others
5. **Alarms** – Display any system alarms or warnings, and these can be filtered by severity
6. **Settings** - set CZone parameters, rather than other on-board equipment. This includes units of measurement, backlight settings, time zones, network settings etc.

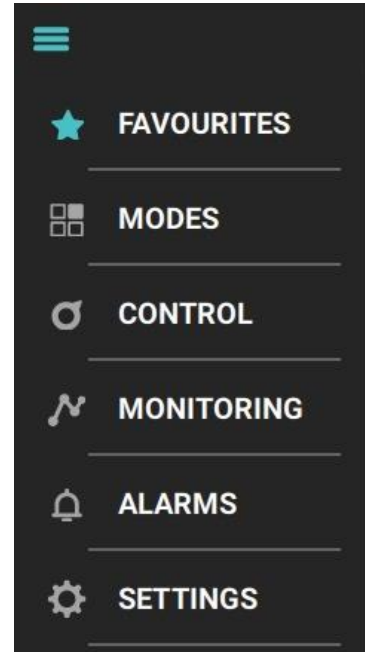

Touch 5 offers a slide-out main menu which auto-hides to display as an icon in the top left corner of the screen. Tapping on this causes the full menu to slide out with a tab for each of the above functional groups. The menu auto-hides when one of the main tabs is selected, or when the icon is tapped.

To access any function in a group, start by clicking its menu option. The GUI will display a list of items under the group, with specific details of the item selected home page.

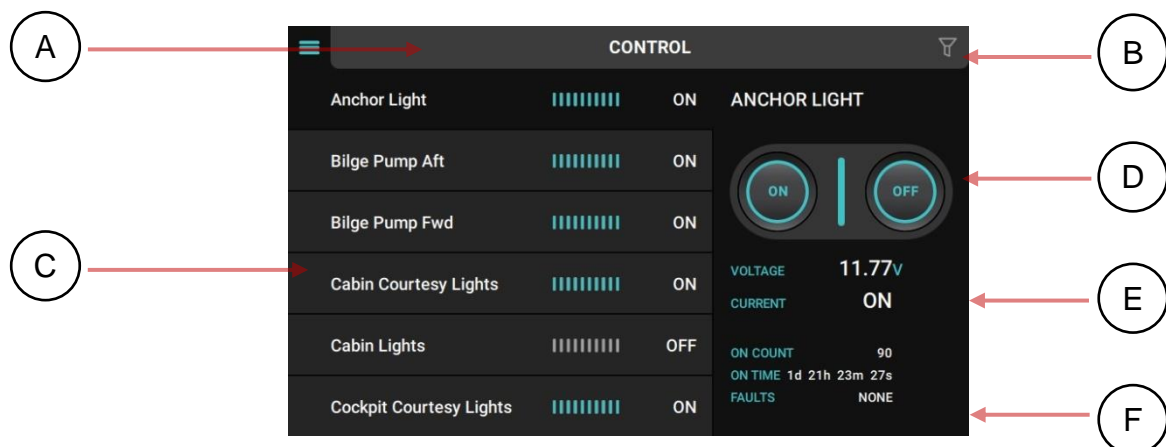

- A. Title, showing name of current functional group (Control).
 - B. Filter option. Tapping this allows items to be filtered by category.
 - C. List of items. The number of items in this list of this will be determined by what has been configured on the network.
 - D. Touch control for the current circuit. In this example, the anchor light is shown, and there are touch buttons for turning this on or off.
 - E. Further information about the circuit is displayed, such as the voltage, current state, length of time it has been turned on etc.
 - F. The state of each of the circuits is shown (on and off) and, if the circuit has a variable level (such as a fan which can run at lower speed or a light which can be dimmed), then the current level is shown.
-

4.2 CZone Favourites Pages

The Favourites pages are a quick and easy way for the user to visualize where circuits and alarms are located, and act directly from that visual interface. Favourites pages are created using the CZone Favourites Tool, and are loaded into the Touch 5 through an SD card or over the wireless network. If Favourites pages have been loaded into the Touch 5 then the first page of that set will display when the unit is turned on.

Since every vessel will have a different layout and different graphics, this document can only give indications of how the Favourites page will have been created and what functions will appear there. Multiple favourites pages can be created, and the user swipes left and right between them to access the page they require.

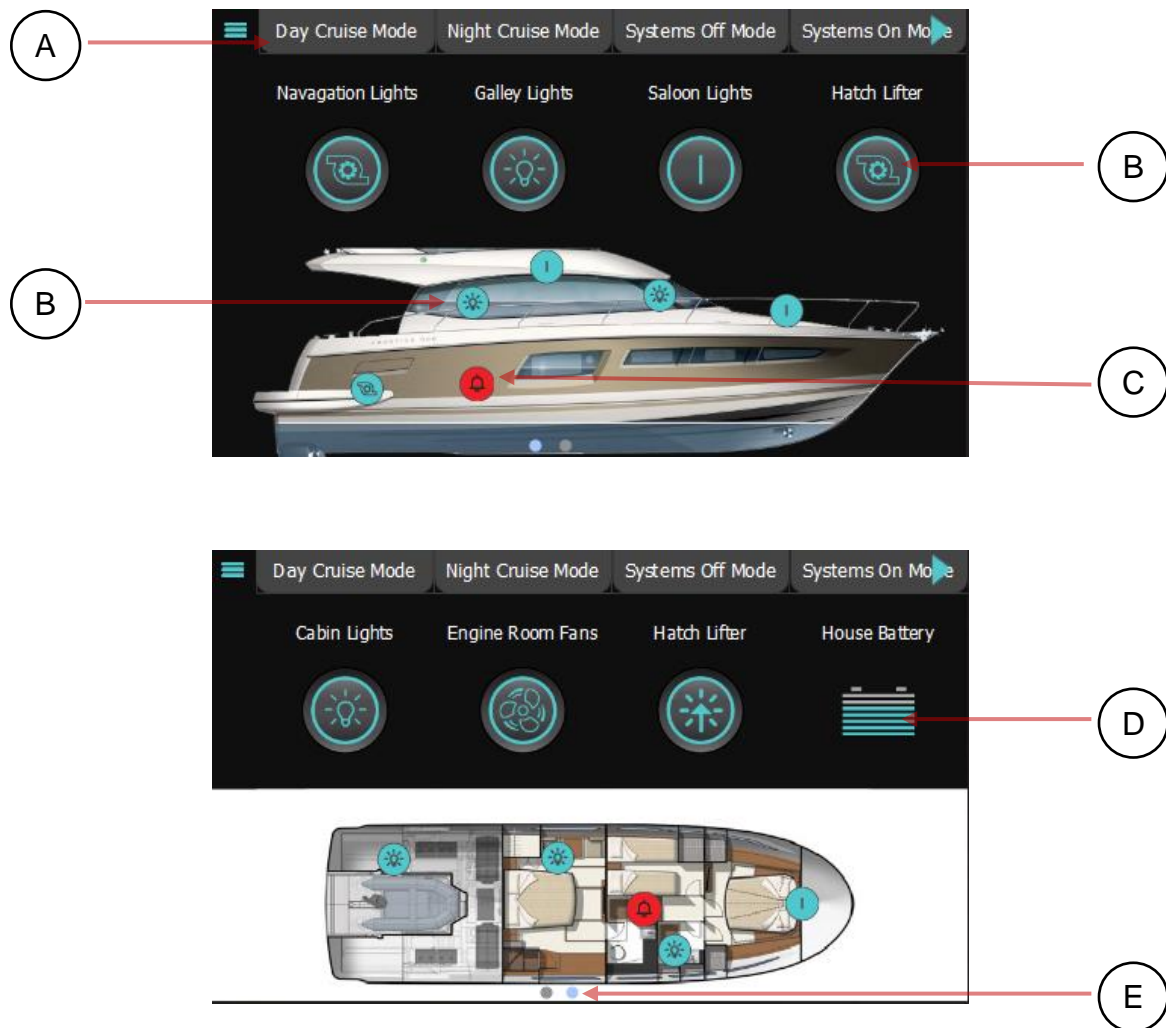

- A.** Modes, allowing quick control of groups of functions. See Section 4.3.1 Modes
- B.** Controls, allowing individual items to be turned on or off. See Section 4.3.2 Control.
- C.** Alarms, showing items that need attention. See Section 4.3.4 Alarms
- D.** Monitoring of specified levels, such as batteries or tank levels. See Section 4.3.3 Monitoring.
- E.** Indication that there are multiple favourites pages. Swipe left and right to swop between pages.

4.3 CZone Functions by Group

4.3.1 Modes

The Modes group is very simple to navigate because it has only one level. This is deliberate: changing modes is intended to reconfigure the systems operation as easily as possible. Modes will vary between vessel or vehicle and are usually configured by the builder, although can be modified later with the CZone Configuration Tool.

Select Modes as the second option from the menu. If a favourites page has been configured then the modes will be listed in a bar along the top of the screen. Although the display depends on how the favourites have been configured, their operation is the same.

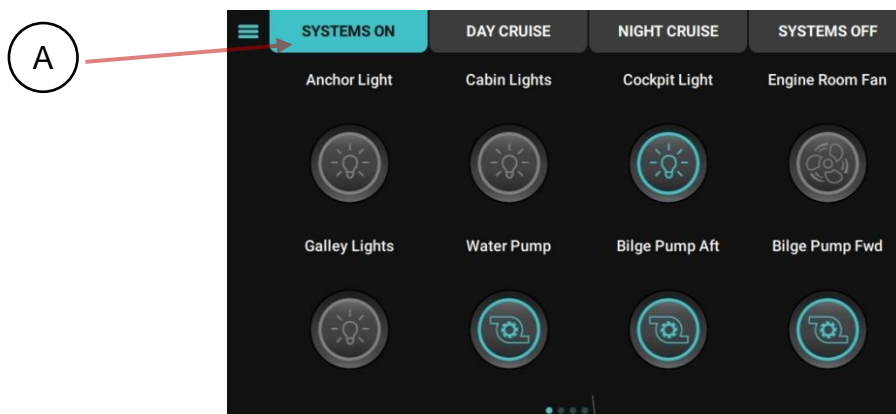

- A. To activate a Mode on the Favourites pages, hold the desired Mode button for half a second. The button will illuminate white, and then change to blue indicating The Mode is now active.

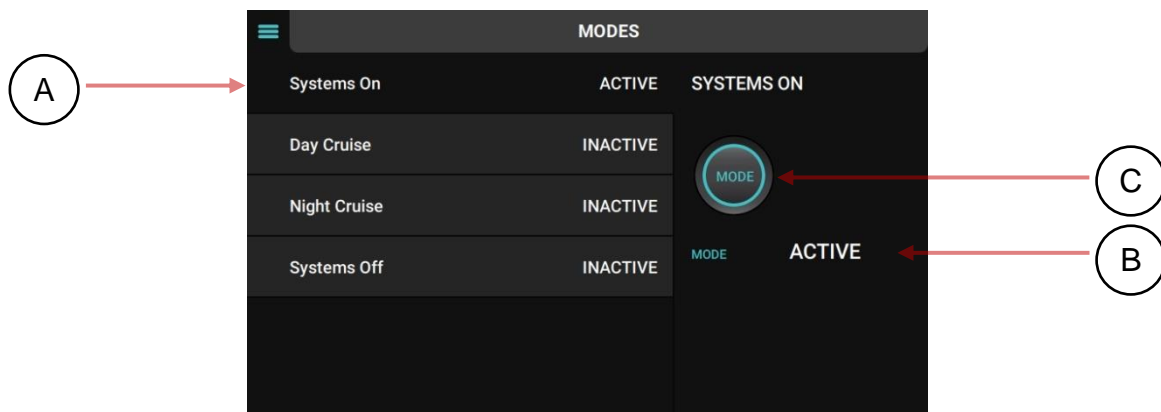

- A. To activate a Mode on the Modes page select the desired Mode from the Mode list.
- B. The Mode information panel will display the current state of that mode (Active or Inactive) and any other relevant information.
- C. Press the button to activate the Mode.

Modes are configured by the builder using the CZone Configuration Tool. Only one mode from a 'mode group' can be selected at a time; most systems have only one mode group.

If the Modes page shows two or more modes Active then the system has more than one mode group. In that case, several modes can be in force at a time, one from each group, and an Off button may appear beside the On button shown above.

Below is an example of the modes configuration which summarises the effect that selecting a mode has on the vessels systems. The builder should supply a similar summary for each of the modes configured.

	Modes Configuration			
	Systems On	Day Cruise	Night Cruise	Systems Off
Backlight Zone 1	On	On	On (30.0%)	Off
Cabin Lights	On	Off	On (2.0%)	Off
Charger	Not Used	Not Used	Not Used	Not Used
Courtesy Lights Blue	Off	Off	On	Off
Courtesy Lights White	On	On	Off	Off
Fan	Off	On	On	Off
Fresh Water Pump	On	On	On	Off
Galley Lights	On	Off	On (2.0%)	Off
Hatch Lifter	Not Used	Not Used	Not Used	Not Used
Navigation Lights	Off	Off	On	Off
Saloon Lights	On	On	On (2.0%)	Off

4.3.2 Controls

The main menu's Control option accesses all configured circuits on the CZone network. Note that individual controls can also be dropped onto the favourites page, where they will behave similarly.

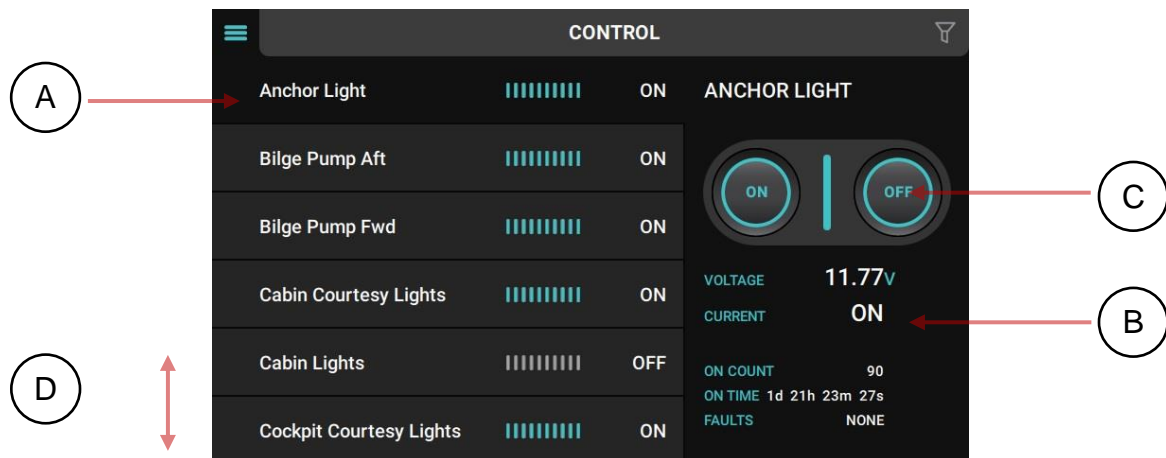

- Select the circuit you wish to control
- The Control information panel will display the current state of that circuit (On or Off) and any other relevant information.
- Press the On or Off to buttons to toggle the circuit on or off.
- Swipe up or down to scroll between controls, if there are too many to fit on the screen.
- Alternatively, the controls can be filtered. Tap on the Filter icon to see the options available.

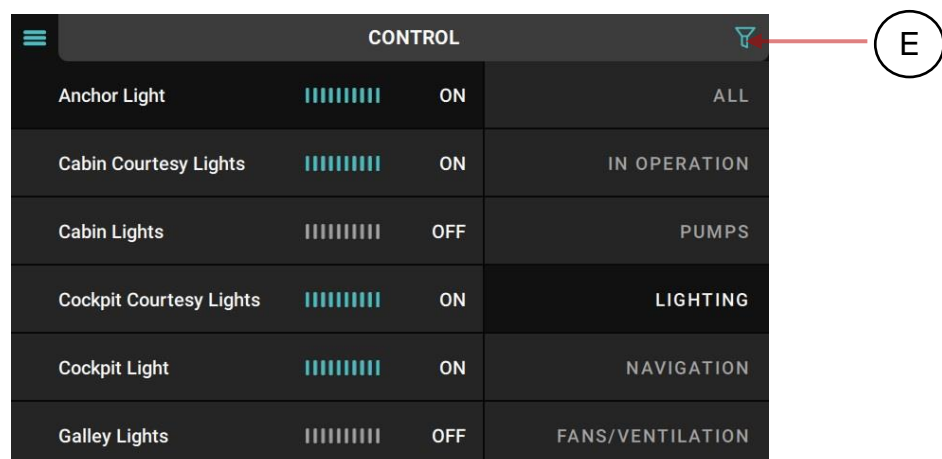

Controls are configured by the builder using the CZone Configuration Tool. Depending on which CZone modules are on the network, you may have one or more of the following four circuit types:

- DC Control** - 12V or 24V DC loads, such as LED lights and fresh-water pumps. Some circuits may be adjustable (such as lights that are dimmable) and these are adjusted by touching and holding the control down.

- **AC Control** - 120V or 230V AC loads, such as air conditioning and AC outlets.
- **AC Mains Control** - a page for controlling/monitoring AC mains supplies (e.g. generator and/or shore power). (Note: Requires a CZone AC Mains Interface.)
- **Inverters/Chargers** - a page for controlling/monitoring Mastervolt Inverter/Chargers.

All AC and DC circuit types are accessible through the Controls category, although the information displayed about the circuit will change. Circuits may also be assigned a group category such as Lights or Pumps which allows circuits on large systems to be accessed quickly. Controls may also be dropped onto the Favourites Page, either as individual controls on the page or as icons indicating their locations on a boat image.

4.3.3 Monitoring

The main menu's Monitoring option accesses all circuits configured for monitoring on the CZone network.

Depending on which CZone modules are on the vessel, you may have one or more of the following five monitoring types:

- **DC Monitoring** - 12V or 24V supplies such as house or starter batteries, and chargers
- **AC Mains** - 120V or 230V AC sources, such as shore power supplies, on-board generators and inverters
- **Tanks** – levels for tanks such as fresh-water, fuel, black water or grey water
- **Temperatures** – such as coolant or engine room temperatures

There may also be a Favourites category which will be configured by the builder for fast access to essential monitoring items.

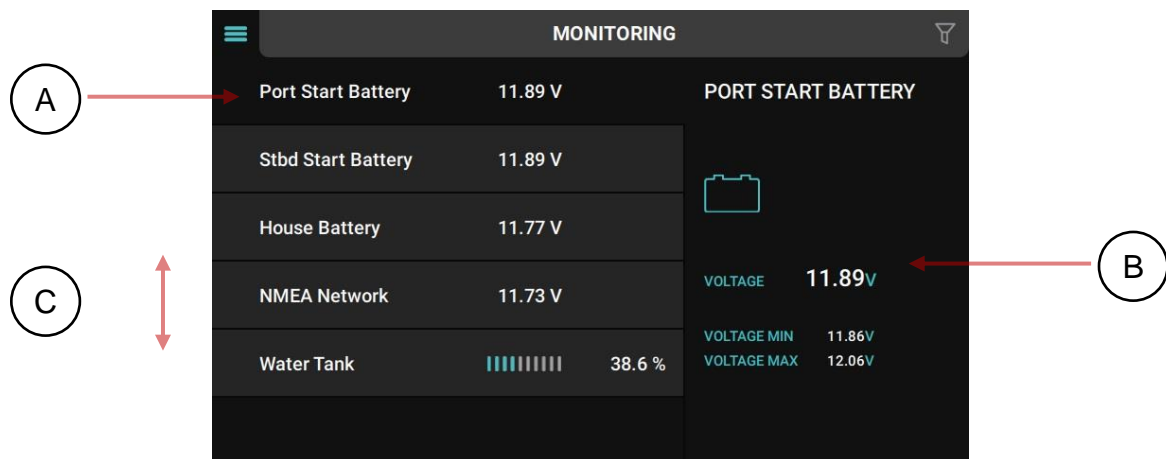

- Select the sensor you wish to monitor. The menu item lists the current value of each monitored item.
- The information panel will display more detail about the current state of that sensor (Voltage, tank level, temperature etc). Mins and Max levels are also monitored for AC and DC power.
- Swipe up or down to scroll between items being monitored, if there are too many to fit on the screen.
- Alternatively, the controls can be filtered. Tap on the Filter icon to see the options available.

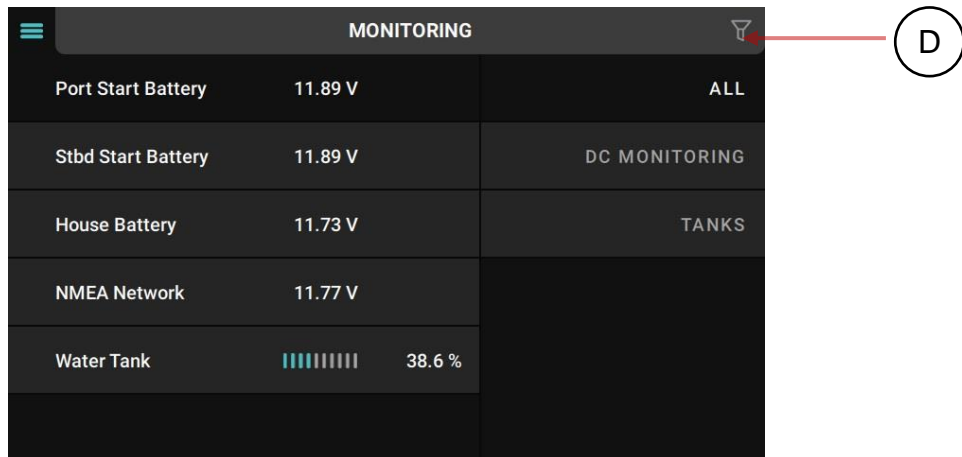

MONITORING		
Port Start Battery	11.89 V	ALL
Stbd Start Battery	11.89 V	DC MONITORING
House Battery	11.73 V	TANKS
NMEA Network	11.77 V	
Water Tank	38.6 %	

4.3.3.1 DC Monitoring

All DC Monitoring meters behave in the same way. An example is shown below:

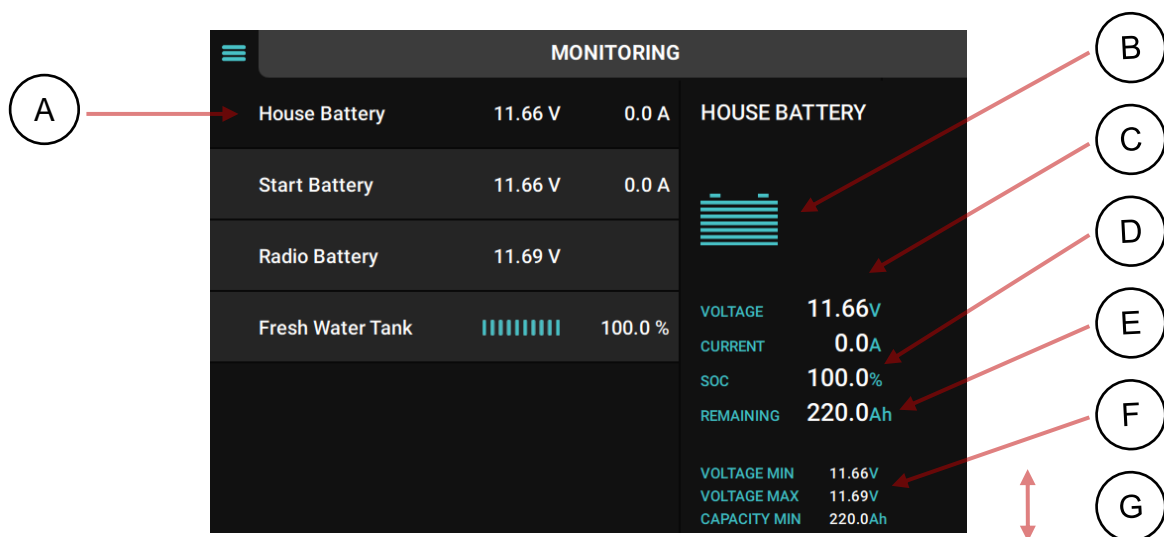

MONITORING		
House Battery	11.66 V	0.0 A
Start Battery	11.66 V	0.0 A
Radio Battery	11.69 V	
Fresh Water Tank	100.0 %	

HOUSE BATTERY	
VOLTAGE	11.66V
CURRENT	0.0A
SOC	100.0%
REMAINING	220.0Ah
VOLTAGE MIN	11.66V
VOLTAGE MAX	11.69V
CAPACITY MIN	220.0Ah

- The Voltage and Current drawn are shown alongside the menu item for quick reference.
- An icon shows the type of DC monitoring item (Battery). Some DC batteries also include State of Charge monitoring, for these systems the battery symbol will double up as a State of Charge % level indicator.
- The present voltage and current draw are displayed.
- The calculated state of charge is shown as a percentage of full charge.
- The calculated remaining capacity is shown, in ampere-hours.
- The maximum and minimum recent states of the battery are reported.
- Information items can be scrolled up to see additional details

4.3.3.2 AC Mains

The AC Mains page will appear if an AC Mains Interface (ACMI) is configured on the system. It provides a graphical interface for directing power between AC mains sources e.g. on board generators and shore power connections and AC Loads e.g. air conditioners and power outlets. An example with 4 AC Inputs and 2 AC Outputs is shown below

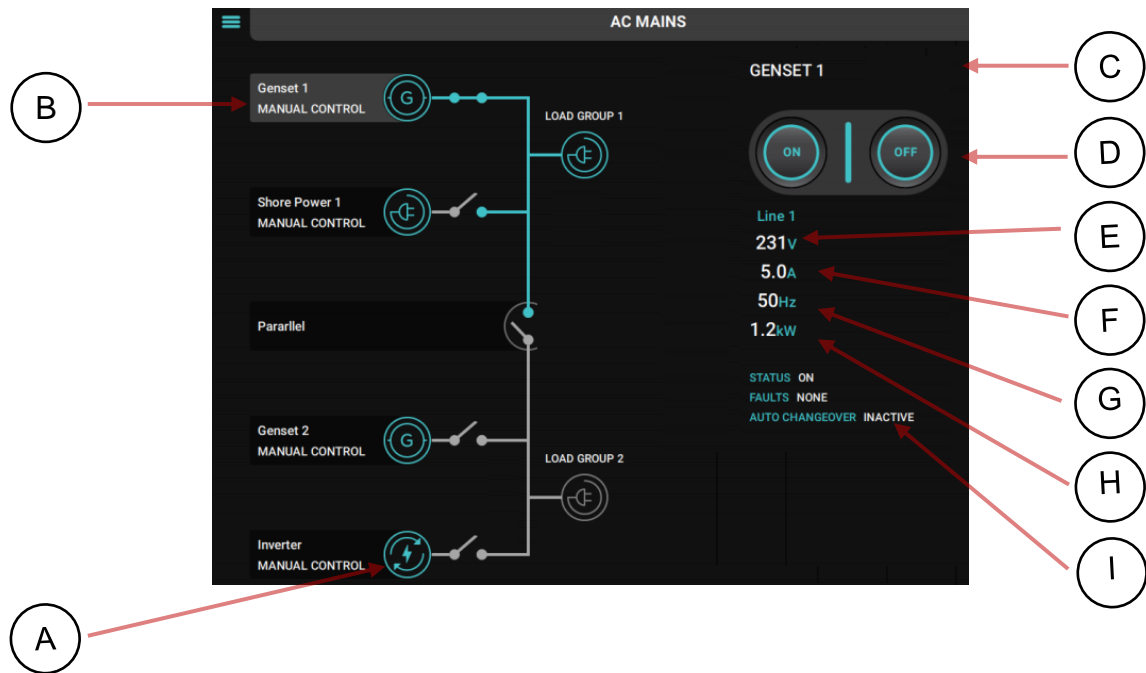

- A. The AC Power state is shown for each source. Icon is highlighted if there is power.
- B. The highlight shows the currently selected AC source.
- C. The name of the selected power source is displayed.
- D. The source can be controlled through touch switches.
- E. The status of the RMS voltage of the selected AC Mains source is shown.
- F. The total amperage being delivered from the power source is shown.
- G. The frequency of the power source is shown.
- H. The real power being supplied to all load groups supplied by the source is shown
- I. Status and faults of the power source is shown.

4.3.3.3 Tanks

All Tank monitoring meters behave in the same way. An example is shown below:

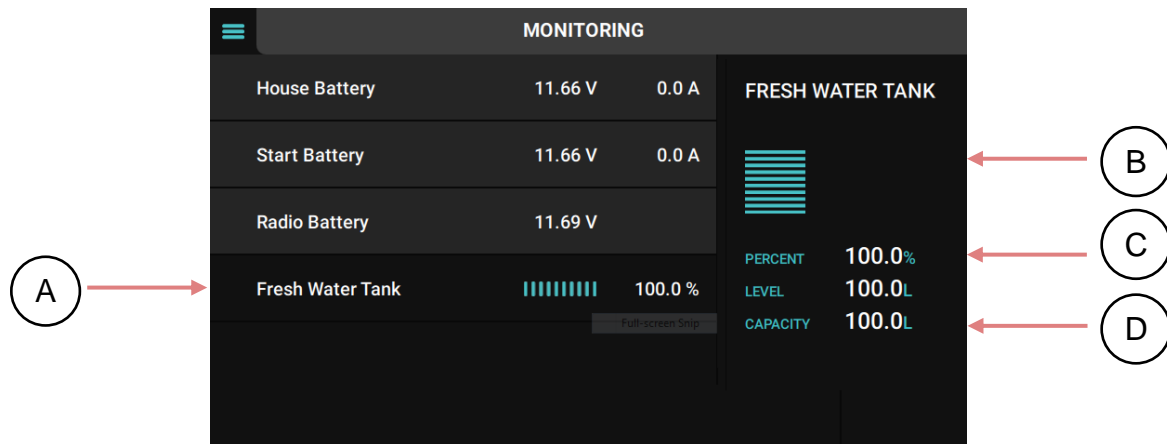

- A. The current level in the tank is displayed visually and as a percentage in the menu.
- B. The large gauge shows the tank level %
- C. The tank's level is reported as a percentage and in the units of measure.
- D. The capacity of the tank is shown in the configured units.

4.3.4 Alarms

Alarms are configured to specifically draw attention to an item that needs immediate attention. The Menu option accesses all configured alarm items on the CZone network. Alarms can also be dropped onto the vessel image, to provide a visual indication of where the alarm is as well as the detail of it.

Alarm monitoring behaves in the same way for all levels of severity. On selecting Alarms from the Menu, you can select historical alarms, or active alarms of any severity.

4.3.4.1 Alarm Activated

Alarms that are activated will display as a pop-up over any other active screen. Only higher level alarms will pop up – warnings will still be reported in the system but will not pop over other displays.

The user only has one option, to acknowledge the alarm and close the popup.

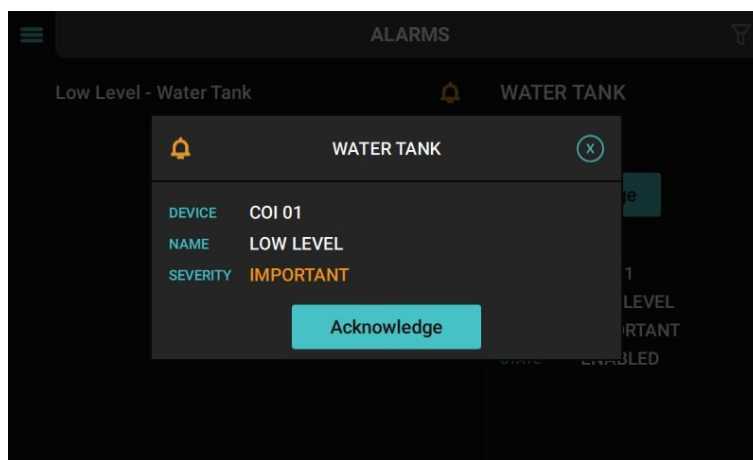

4.3.4.2 Alarms of a Selected Severity

Below is a list of the different CZone alarm severities and their behaviour:

Alarm Level	Bell Colour	Action on Trigger	Additional Note
Critical	Red	Full-Screen Dialog, Audible Tone	Acknowledgement times out after 10 minutes then re-alarms
Important	Orange	Full-Screen Dialog, Audible Tone	Acknowledgement times out after 10 minutes
Standard	Yellow	Full-Screen Dialog	Full-screen dialogue disappears once alarm is acknowledged
Warning	Blue	Bell Appears	Bell disappears once alarm is acknowledged

4.3.4.3 Alarm Page

Below is an example of the current alarms page.

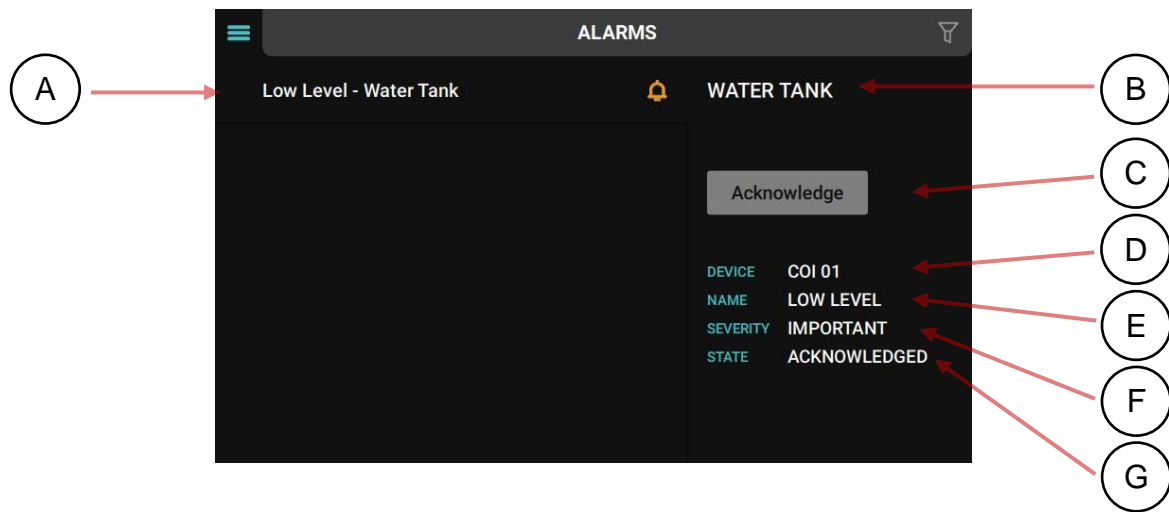

- A. A list of active alarms appears, all with their severity level. More-recent alarms are listed first. (In this example, the Low Level alarm from the Fresh Water Tank is the only important alarm currently active.)
- B. The name of the input that raised the alarm is shown in the display pane
- C. The alarm state is shown. There are two possible values: Enabled and Acknowledge
- D. The CZone module that detected the alarm is shown
- E. The name of the alarm is displayed
- F. The severity is shown.
- G. The alarm state is shown.

4.3.4.4 Alarm History

Selecting Alarm History from the Monitoring > Alarms page displays the most recent alarms (up to 100). Alarms are listed according to when they were raised, with the most recent first. Alarm history includes all alarms above Warning severity by default. The minimum severity saved in history can be changed from the Settings > System > Alarm Log Severity page.

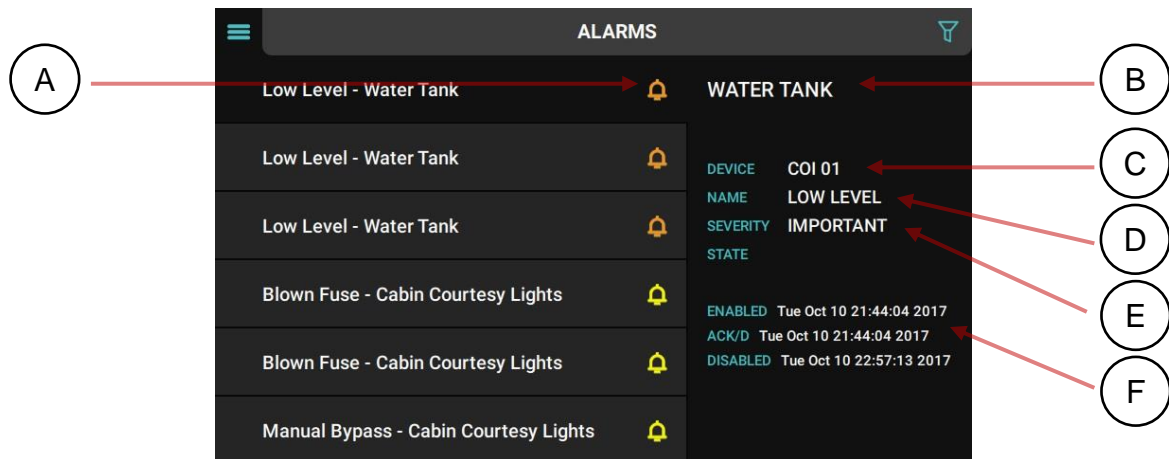

- A. The alarm severity is indicated with a bell-shaped icon of the appropriate colour.
- B. The name of the input that raised the alarm is shown.
- C. The CZone module that detected the alarm is shown.
- D. The name of the alarm is shown.
- E. The severity of the alarm is reported in words.
- F. The date/time stamps for the alarm are:
 - when it was raised (i.e. enabled).
 - when it was acknowledged.
 - when it was cancelled (i.e. disabled).

4.3.5 Settings

The Settings tab lets you query and change various parameters of the Touch 5, including measurement units (gallons, litres, etc.), the network configuration, date/time and others.

4.3.5.1 Settings Menu

The settings menu provides access to all the system settings. It is important to note that most options contain more items than can fit on the screen, so always remember to swipe up or down to scroll to see other items.

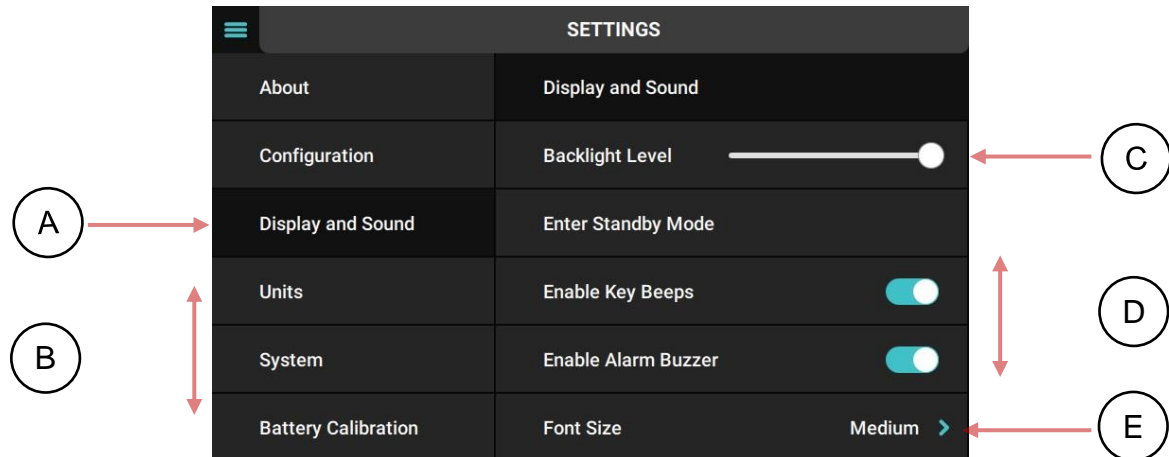

- A. The currently selected menu category.
- B. Swipe up or down to access more menu items.
- C. Select the item you wish to set. Various actions are possible (See section 4.3.5.2)
- D. Swipe up or down for more options.
- E. An arrow indicates there are further options. Tap on this to open the page to access these.

4.3.5.2 Settings screens

Most of the settings screens are self-explanatory, and hence the Display and Sound and System screens are shown here for illustration only.

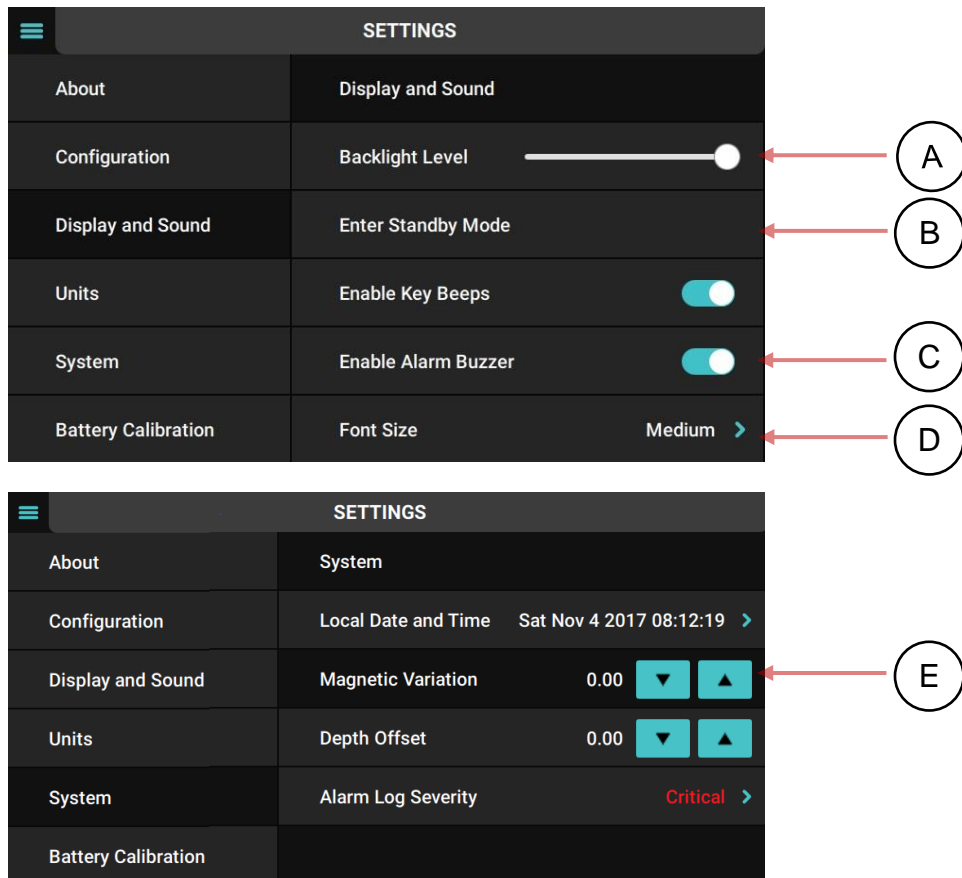

- A. This is a slider, which allows continuous variation of the value. Slide your finger along the bar to set a value.
- B. This enters a specific mode, and the only option is to tap the mode name to activate it.
- C. This sliding on/off button sets a value on or off. Tap to toggle between the values.
- D. This indicates a further slide-out menu of options. Tap to access that menu.
- E. This incrementally increases or decrease the value by a pre-set amount. Tap and hold on one of the buttons to scroll quickly through the values.

4.3.5.3 CZone Network status

Occasionally you need to check that status of the CZone network and the devices on it. You access this from the Settings > Network menu, and each interface device that has been configured for your installation will be listed. Note these are the interfaces, not the individual circuits connected to that device.

SETTINGS	
System	Network
Battery Calibration	Display Interface (DI) Online >
NMEA 2000 Monitoring	Meter Interface (MI) Offline >
Wireless Server	Motor Output Interface (MOI) Online >
Network	Output Interface (OI) Online >
Reset	Touch 5 Online >

If you wish to check more details of a specific network device, touch the blue arrow next to the interface and the details of that device will be shown, including any device-level faults.

SETTINGS	
System	Network
Battery Calibration	Name Display Interface (DI)
NMEA 2000 Monitoring	Type Display Interface
Wireless Server	Status Online
Network	Dipswitch 10000100
Reset	Version 12.0.2.224-gfc0617b-d

4.4 Updating Software

To keep the Touch 5 up to date with the latest software refer to www.czone.net. It is recommended to update the entire CZone system when updating the Touch 5 to ensure the system operates correctly. The Touch 5 can be updated via the microSD card slot, see process below:

4.4.1 Checking Current Software Version

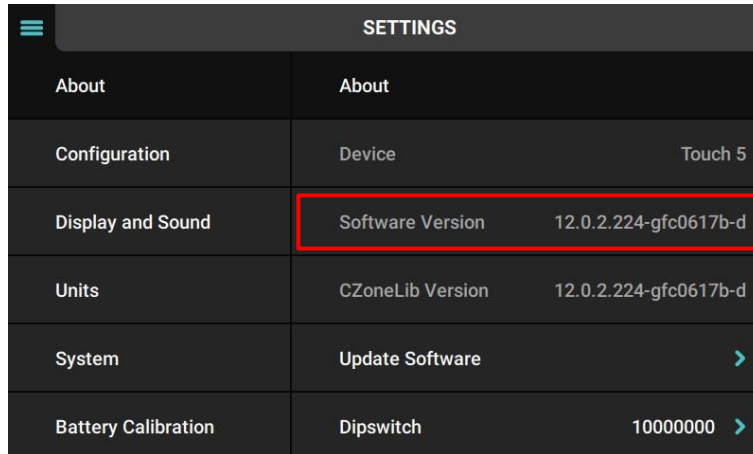

SETTINGS	
About	About
Configuration	Device Touch 5
Display and Sound	Software Version 12.0.2.224-gfc0617b-d
Units	CZoneLib Version 12.0.2.224-gfc0617b-d
System	Update Software >
Battery Calibration	Dipswitch 10000000 >

To check the current software version on the Touch 5, go to Settings > About.

The current software version is listed at the top of the page. To install a newer version, follow the below steps

4.4.2 Updating Software via microSD

1. Copy the Touch 5 firmware file (extension .upd, previously downloaded from the CZone web site) on the root directory of a microSD card.
 2. Insert the microSD card in the card reader slot of the Touch 5 (refer to chapter 1.2.4 for process).
 3. Press the 'Update Software' button on the Settings > About page and press 'Yes' when prompted (Alternatively, the update will start if the power on the Touch 5 is cycled).
 4. The display will reboot and start installing the new software, this process may take a few minutes.
 5. When complete the display will boot up to the main screen. Go to Settings > About to confirm the new Software Version.
-

4.5 Connecting iPad to Touch 5

Follow the below steps to connect an iPad to the Touch 5 via Wi-Fi. Before proceeding a WI package must be present on the Touch 5's CZone server, this package contains the custom favourite page settings and images. Refer to the CZone Wireless Interface Setup instructions for this process.

1. Download the CZone App on your iPad from the Apple App Store.
2. On the Touch 5 Go to Settings > Wireless Server
3. The following screen will show the Touch 5's unique SSID and Password

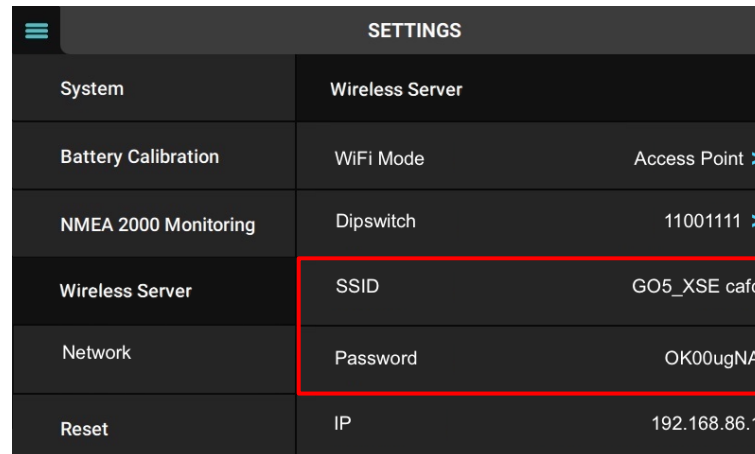

4. Go to Settings > WiFi on your iPad, select the SSID and enter the Password as shown on the Touch 5 Wireless Server Info
5. Once your iPad has successfully connected open the CZone App:
6. Enter the server username and password and press connect

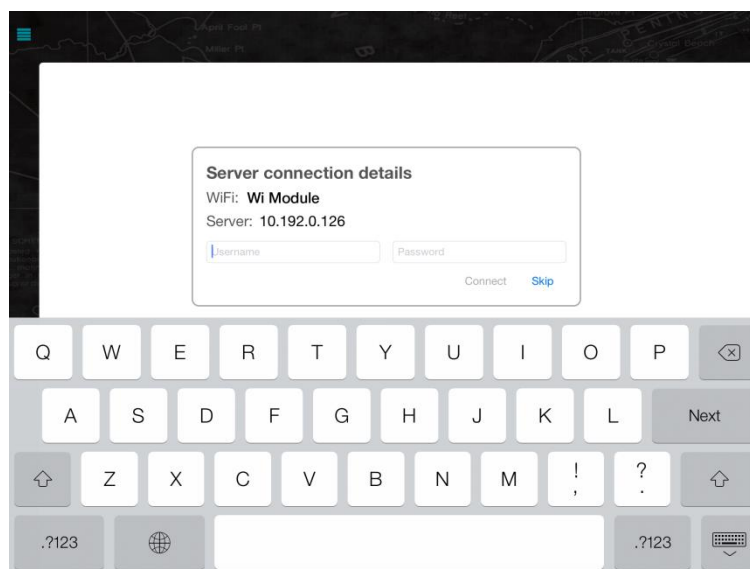

- The Wireless package will start downloading

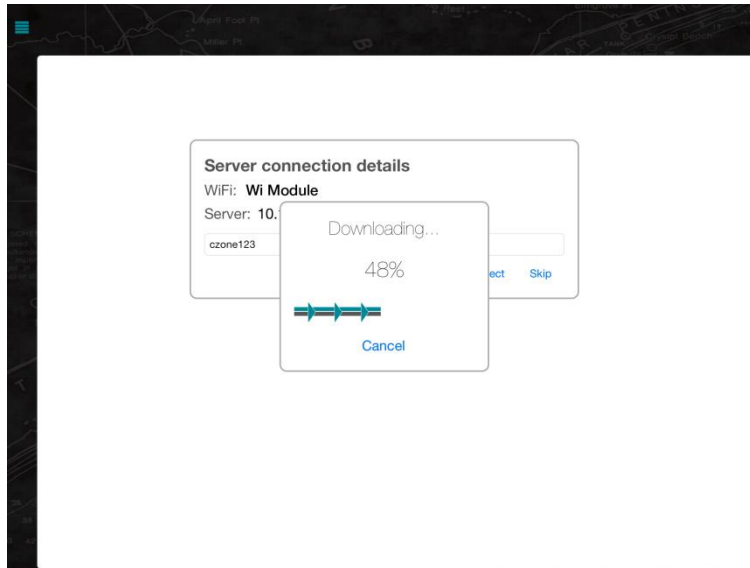

- Once the download is complete you will see the favorites page of the configured system.

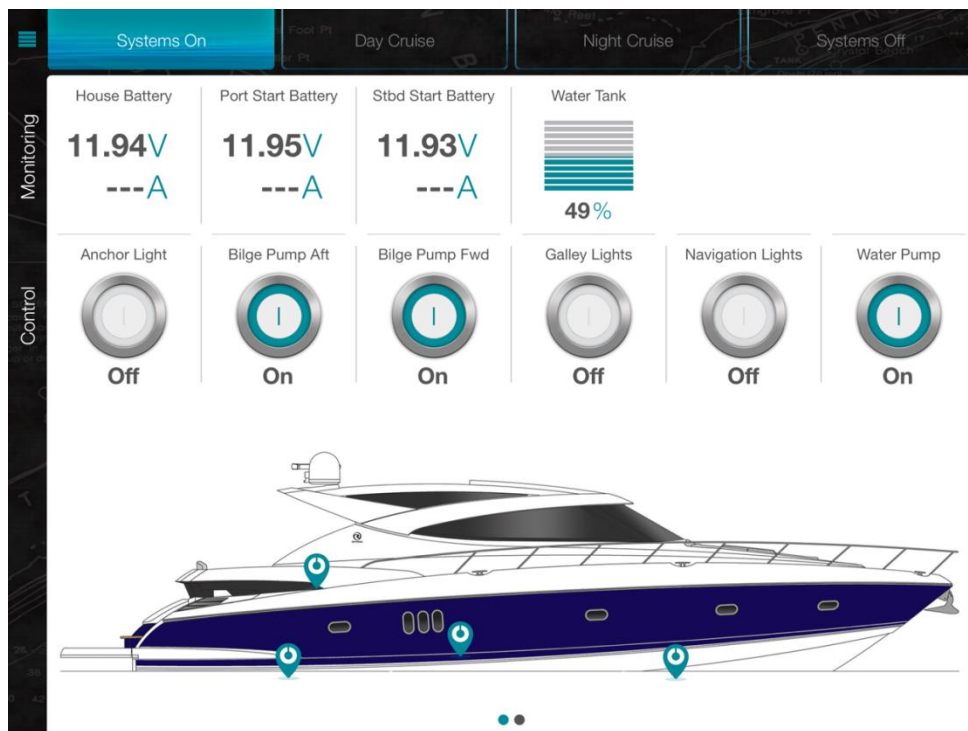

Figure 2. CZone iPad App Favourites Page Example

5 Specifications

5.1 Technical Specifications

Model	Touch 5
Article number	80-911-0124-00
Casing	PCB/ABS
Display Type	WVGA Colour TFT LCD
Display Resolution	480 x 800 pixels (H x W)
Screen Brightness	1200 nits
Operating Temperature	-15°C to +55°C (+5°F to +131°F)
Water Ingress	IPX6 and 7
Operating Voltage	10 – 17V DC
Power Consumption	900mA @ 13.5V
Processor	iMX61 single core
Weight (excluding mounting hardware)	526 grams (1.16lbs)
Conformity	CE, C-Tick

5.2 Dimensions

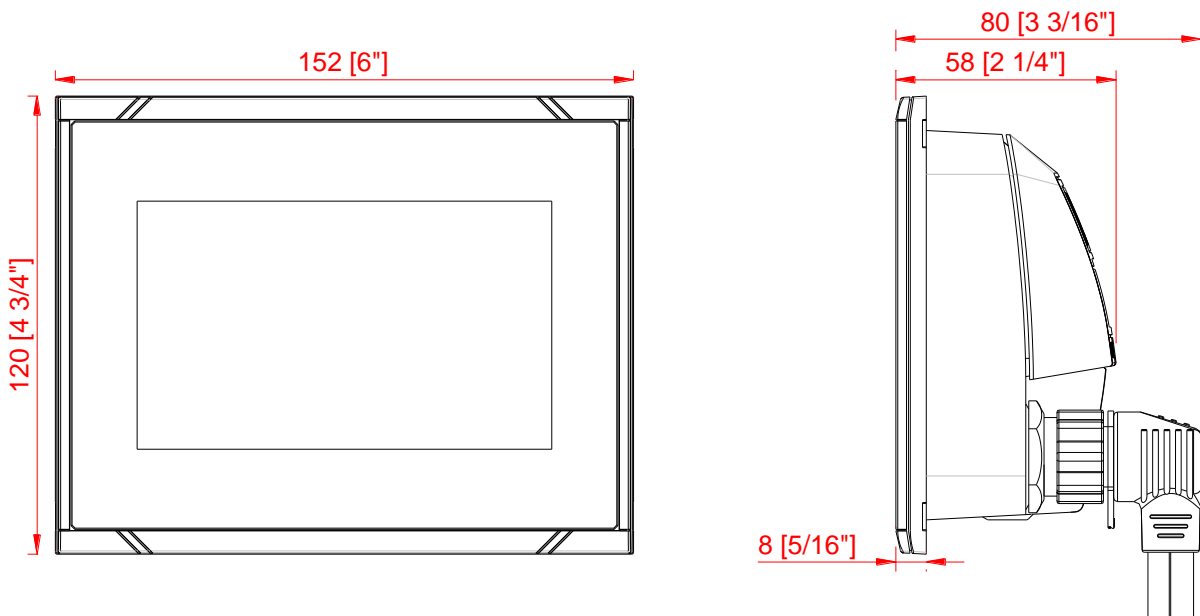

Figure 3. Dimensions

6 EC DECLARATION OF CONFORMITY

We,

Power Products LLC

Mailing Address:

BEP Marine LTD

PO Box 101-739 NSMC

Auckland 0632, New Zealand

Street Address:

42 Apollo Drive

Rosedale,

Auckland, 0632, New Zealand

Declare under our sole responsibility that the following product to which this declaration relates is in conformity with the requirements of EU directive 1999/5/EC R&TTE (Radio and Telecommunications Terminal Equipment) and satisfies all the technical regulations applicable:-

Type : CZone, Touch 5 Display
Brand : BEP Marine
Model : CZONE TOUCH 5 KIT
P/N 80-911-0124-00

To which this declaration related, is in conformity with the following standards or other normative documents:-

EMC : EN 60945:2002
EN 301 489-1 V1.9.2
Health & Safety : EN 60950-1:2006
Radio : EN 300 328 V1.9.1
EN 300 440-2 V1.1.1

Albany, New Zealand, 15 March 2017



Mark Griffith
R & D Manager

BEP Marine Ltd

42 Apollo Drive
Rosedale, Auckland
New Zealand
Tel:64-9-415-7261
