

AIRPAX

IAL/IUL/IEL/LEL
Magnetic Circuit Protectors





IAL/IUL/IEL/LEL Single Pole Circuit Protectors	139
IAL/IUL/IEL/LEL Multi-Pole Circuit Protectors	140
IAL/IUL/IEL/LEL BX Style Circuit Protectors	141
LELHP/CELHP Magnetic Circuit Protectors	142
IALN/IULN Panel Seal Circuit Protectors Rocker Handle Styles	143 144
IAL/IUL/IEL Configurations	145
Mid-Trip Indication/Snap-In Mounting Options	147
ROCB Remote Operated Circuit Breaker	148
IAL/IUL/IEL/LEL Operating Characteristics	149
IAL/IUL/IEL/LEL Delay Curves	150
IAL/IUL/IEL/IDL/LEL Specifications	154
IAL/IUL/IEL/IDL/LEL/LELHP Specifications	155
IAL/IUL/IEL Decision Tables	156
LEL Decision Tables	158
LELHP Decision Tables	160

IAL/IUL/IEL/LEL magnetic circuit protectors provide low-cost power switching, reliable circuit protection and accurate circuit control for equipment in the international marketplace.

IAL models are for those applications where the unit's inherent attributes are desired, but compliance with the various standards is not required.

IUL models have been tested and approved in accordance with UL 1077 requirements for UL recognition.

IEL/LEL models are VDE approved to VDE 0660, part 101. They meet IEC spacing requirements, mandatory for equipment which must comply with IEC specifications 601 and 950, and VDE specifications 0804 and 0805. In addition, the IEL models are UL recognized to UL 1077 as supplementary protectors and the LEL models are UL listed under the conditions of UL 489. Both are CSA certified and CCC Approved. The IEL is CSA certified as a supplementary protector per CSA C22.2–No. 235.

Airpax type IAL/IUL/IEL/LEL circuit protectors are available in a wide variety of configurations, including series, series with auxiliary switch, shunt and relay with choice of delays and ratings in DC and/or 50/60Hz or 400Hz versions. Single or multi-pole versions are available with a variety of pole arrangements to meet your specifications. Please see the appropriate product specification table for ratings and limitations.



Single Pole, Standard Stud Terminal

M6	.510	.652
1/4 - 20	.545	.687
M5	.510	.652
10 - 32	.545	.687
Screw stud thread	Dim. "A" (± .045)	Dim. "B" (± .035)

Note: Each outer terminal is supplied with a flatwasher, tooth lockwasher and a hex nut.

Single Pole

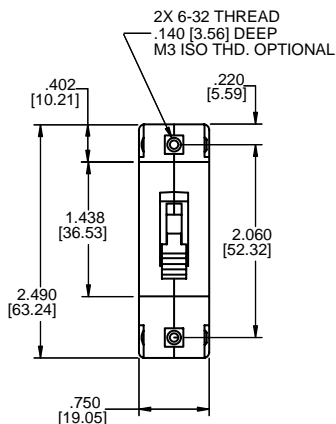

Mounting Detail

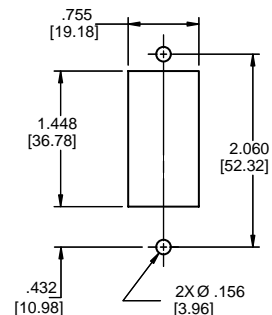

Screw Terminal

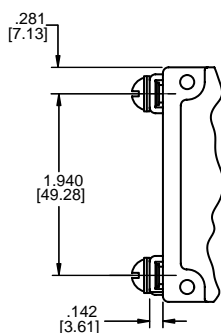

Clip Terminal

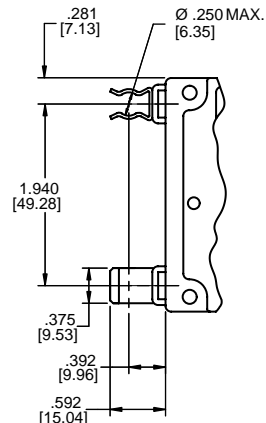

Bullet Terminal

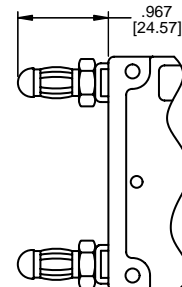

Notes:

Tolerance ± .015 [.39] unless noted. Dimensions in brackets [] are millimeters.

A Terminal protrusion dimensions are referenced from back of mounting panel.

B Each screw terminal is supplied with a 10-32x.312 [7.92] or M5 x 8mm screw, flatwasher and external tooth lockwasher.

C Stud terminals are supplied with a flatwasher, external tooth lockwasher and a 10-32 or M5 hex nut (<=70A) (<=50A for LEL), 1/4-20 or M6 hex nut (>70A)(>50A for LEL).

Bullet terminal receptacle should be .312 ± .001 diameter hole not less than .250 depth. Contact Airpax for other bullet sizes.

IAL/IUL/IEL/LEL MULTI-POLE CIRCUIT PROTECTORS

Multi-pole units are combined in an assembly with the trip mechanisms internally coupled. A fault in any protected circuit opens all poles simultaneously. Applications include use in polyphase circuits, single-phase three-wire systems, or in two or more related but electrically isolated circuits. A mix of delays, ratings and configurations are offered. The auxiliary switch is offered with either gold or silver contacts and is available when a series construction pole is specified.

Two Pole Units

An assembly consisting of two single pole units, having their trip mechanisms internally coupled, is available with either a single toggle handle or with a handle per pole. Please see decision one of the part number decision tables. Individual poles may vary in ratings, delays and internal configurations. If the poles are of series construction, an auxiliary switch may be included in either or both poles, allowing you to mix SELV and hazardous voltages.

Two Pole

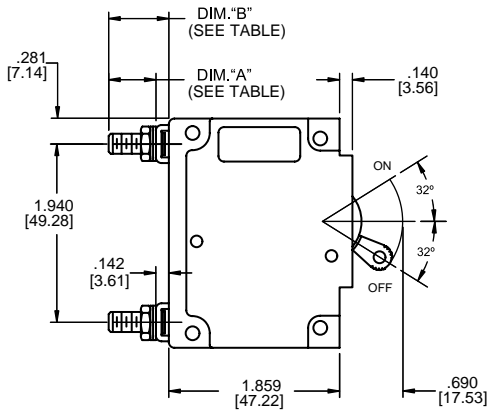

IELH11

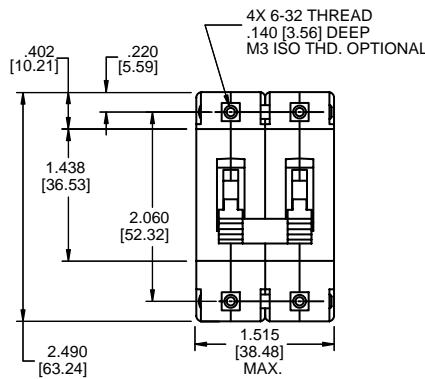

IEL11

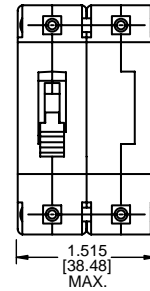

Note:
Tolerance $\pm .015$ [.38] unless noted.
Dimensions in brackets [] are millimeters.

M6	.510	.652
1/4 - 20	.545	.687
M5	.510	.652
10 - 32	.545	.687
Screw stud thread	Dim. "A" ($\pm .045$)	Dim. "B" ($\pm .035$)

Note:
Each outer terminal is supplied with a flatwasher, tooth lockwasher and a hex nut.

Two Pole*

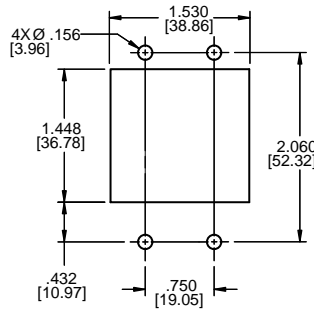

Two Pole*

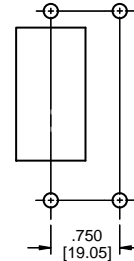

Panel Mounting Detail
Tolerance $\pm .005$ [.13] unless noted.

Note:
A Terminal protrusion dimensions are referenced from back of mounting panel.
B Each screw terminal is supplied with a 10-32x.312 [7.92] or M5 x 8mm screw, flatwasher and external tooth lockwasher.
C Stud terminals are supplied with a flatwasher, external tooth lockwasher and a 10-32 or M5 hex nut ($\leq 70A$), 1/4 -20 or M6 hex nut ($>70A$).

Three Pole and Four Pole Units

The three pole structure consists of three single pole units assembled with an internal mechanical interlock which actuates all units simultaneously. The units are available with either a single toggle handle or with a handle per pole. Units with four pole construction operate with a minimum of two center toggle handles or with a handle per pole. Please see decision one of the part number decision tables. Mixing of delays, ratings and configurations is available in each individual pole. The auxiliary switch is offered in any series trip pole.

Breaker poles are numbered consecutively when viewed from the terminal side, with the ON position up, starting with pole #1 on the left side and proceeding to the right.

Three Pole IEL111

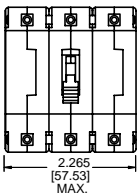

Mounting Detail*

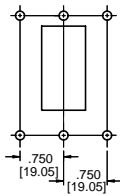

Three Pole IELH111

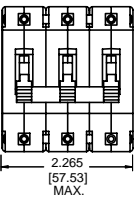

Mounting Detail*

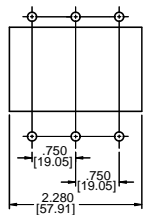

Four Pole IEL1111

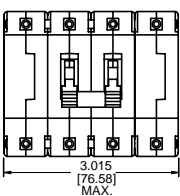

Mounting Detail*

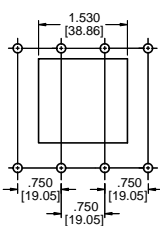

Four Pole IELH1111

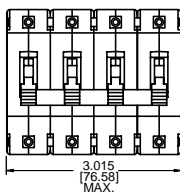

Mounting Detail*

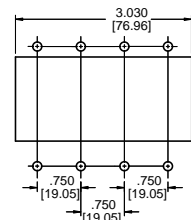

Note:
Tolerance $\pm .015$ [.39] unless noted. Dimensions in brackets [] are millimeters.

*See Single Pole Mounting Detail for Hole Sizes and Locations.

BX Style Circuit Protectors

The innovative new design of our IAL/IUL/IEL/LEL BX Style circuit protectors features a flat rocker that will satisfy your aesthetic needs while guarding against accidental actuation, providing the highest degree of circuit protection and quality. Only Airpax offers this new standard in user interface. Available on a variety of versions with a full range of agency approvals, the IEL BX style circuit protectors meet or exceed all current performance specifications, including interrupting capacities up to 50,000 amperes.

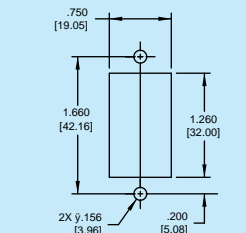
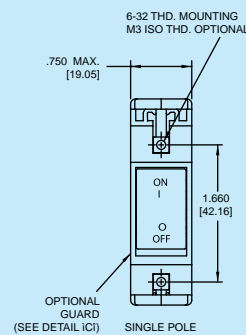
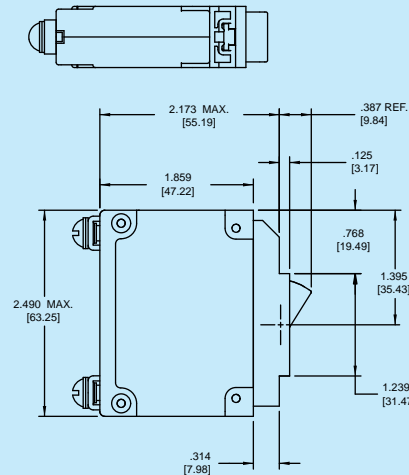

Panel Mounting Detail
Mounting Detail Tolerance: $\pm .005$ [.13] unless noted

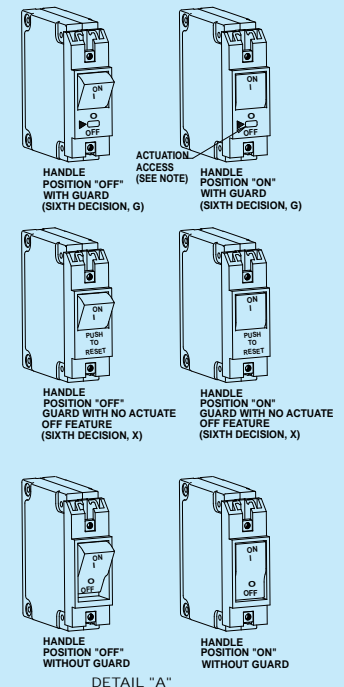

NOTE: ACCESS IS LIMITED TO A DEVICE SMALLER THAN THE UNDERWRITERS LABORATORY "ARTICULATED PROBE" DEFINED IN UL-489 FIG. 11.1.7.2.1.

IAL/IUL/IEL/LEL

LELHP/CELHP MAGNETIC CIRCUIT PROTECTOR

The Airpax LELHP/CELHP high current magnetic circuit protector compliments our entire series of LEL circuit protectors. Its unique, parallel current sensing design provides precise current overload protection and reliability in the compact size of a two pole LEL. The unit is ideal for high power DC applications such as drive motor systems and telecommunication power systems.

It is available in series and series with auxiliary switch configurations with a choice of delays for DC ratings of 125, 150, 175 and 200 amperes. The LELHP is UL listed under the conditions of UL489 and CSA certified. The CELHP is UL listed under the conditions of UL489A. Mid-trip handle indication, voltage trip and remote operator options complete the LELHP/CELHP circuit breaker series. Please see the individual product tables for approved ratings.

Contact Airpax for specific part number.

Two Pole

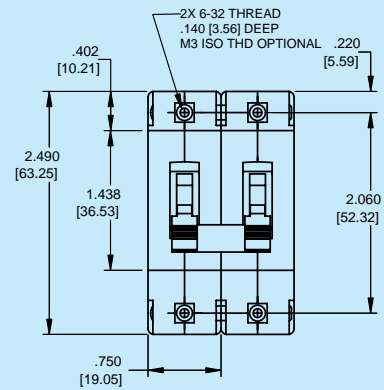
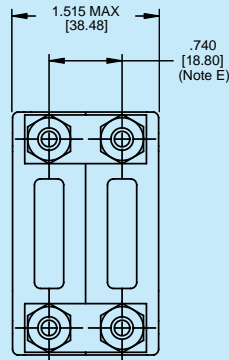
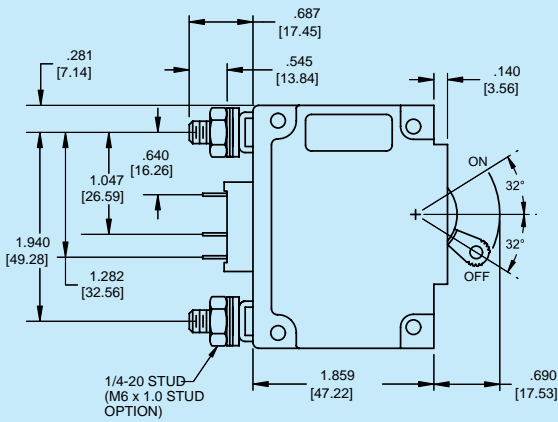

Series Parallel



Series Parallel with optional 1REC4 Auxiliary switch

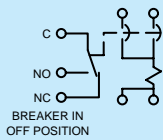

-REC4

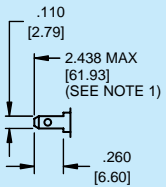

175/200 Parallel Pole

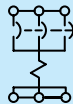

Three Pole (Note D)

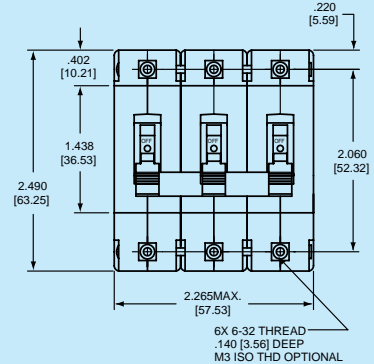
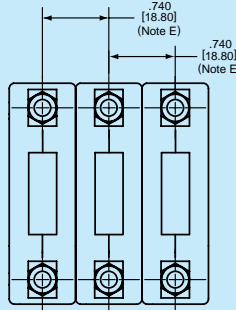

Notes:

Tolerance $\pm .015$ [3.9] unless noted. Dimensions in brackets [] are millimeters.

A Terminal protrusion dimensions are referenced from back of mounting panel.

B Each screw terminal is supplied with a 10-32x.312[7.92] or M5 x 8mm screw, flatwasher and external tooth lockwasher.

C Stud terminals are supplied with a flatwasher, external tooth lockwasher and a 10-32 or M5 hex nut ($\leq 70A$), 1/4 -20 or M6 hex nut ($>70A$).

D Units are supplied without bus bars must have a minimum copper strap (1 31/32 x 1/2 x 1/16) of appropriate length to accommodate connections tying each set of terminals together.

E Other spacing available upon request. Contact factory for assistance.

The IALN/IULN family is a sealed toggle version of the IAL/IUL family. The silicone rubber seal around the handle assures panel seal integrity and makes this style a natural for harsh environments.

This sealed toggle family is available in one to three pole models with ratings of .050 to 100 amperes.

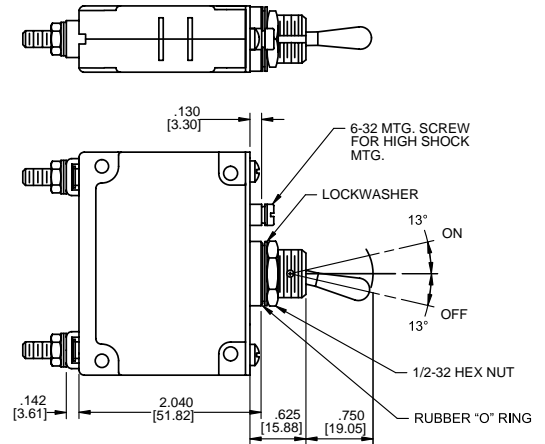

Single Pole

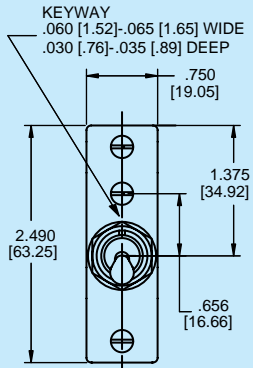

Two Pole

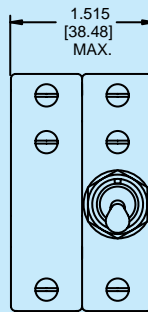

(Optional handle may be in pole 2 instead of pole 1.)

Three Pole

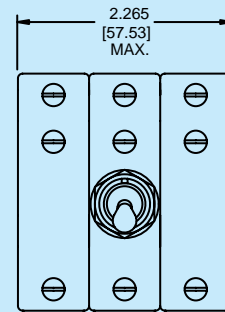

Panel Mounting Details: Tolerance ± 0.005 [.13] Unless noted.

Single Pole

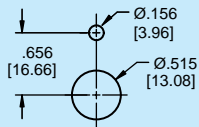

Two Pole*

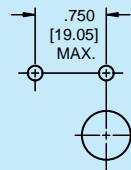

Three Pole*

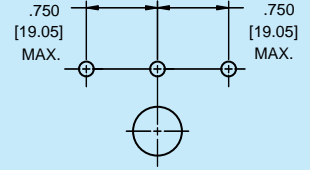

Optional handle

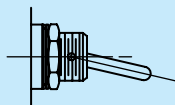

*See Single Pole Mounting Detail for Hole Sizes and Locations.

Notes:

- A Terminal protrusion dimensions are referenced from back of mounting panel.
- B Each screw terminal is supplied with a 10-32x.312[7.92] or M5 x 8mm screw, flatwasher and external tooth lockwasher.
- C Stud terminals are supplied with a flatwasher, external tooth lockwasher and a 10-32 or M5 hex nut ($\leq 70A$), 1/4 -20 or M6 hex nut ($>70A$).

ROCKER HANDLE STYLES

IALX/IULX/IELX Rocker Handle Styles

The rocker style is available in one to four poles. Choose either vertical or horizontal mounting with ON-OFF, international markings or a combination of both. Available .050 to 50 amperes.

Above 50 amperes consult factory.

Five front panel enhancing colors including black, white, red, grey and orange are available.

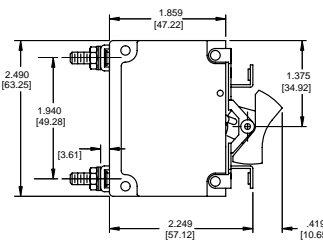
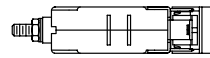

Single Pole

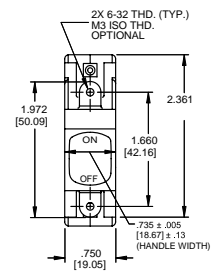

Two Pole

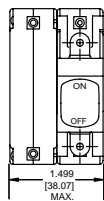

Three Pole

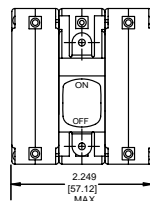

Four Pole

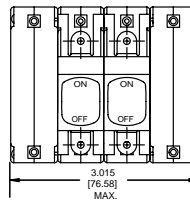

(Optional handle may be in Pole 2 instead of Pole 1.)

Panel Mounting Detail* Single, Two & Three Pole

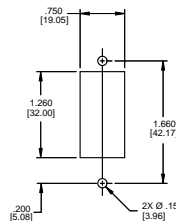

Four Pole**

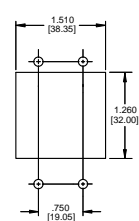

*Mounting detail tolerance $\pm .005$ [.13] Unless noted.
**See single mounting detail for hole sizes and locations.

Note:

- A Terminal protrusion dimensions are referenced from back of mounting panel.
- B Each screw terminal is supplied with a 10-32x.312[7.92] or M5 x 8mm screw, flatwasher and external tooth lockwasher.
- C Stud terminals are supplied with a flatwasher, external tooth lock washer and a 10-32 or M5 hex nut ($\leq 70A$), ϕ -20 or M6 hex nut ($>70A$).

IALZX/IULZX/IELZX Rocker Handle Styles

The IALZX/IULZX/IELZX style adds our rocker handle options of contrasting dual color rocker actuators, affording a clear visual indication of the handle position and integrated handle guards, to help

prevent accidental turn-on and turn-off of the unit. Available with a black rocker and white, red or green indicator color for either ON or OFF indication.

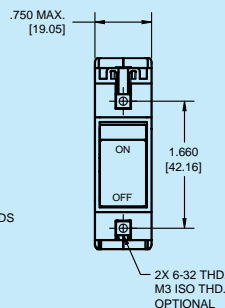
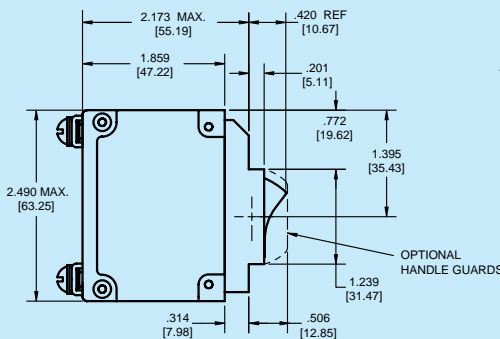

Panel Mounting Detail Mounting Detail Tolerance: $\pm .005$ [.13] Unless Noted.

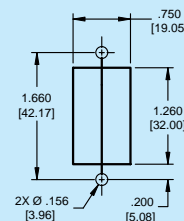

Note: Tolerance $\pm .015$ [.38] unless noted.
Dimensions in brackets [] are millimeters.

IAL/IUL/IEL/LEL

Series Trip

The most popular configuration for magnetic protectors is the series trip where the sensing coil and contacts are in series with the load being protected. The handle position conveniently indicates circuit status. In addition to providing conventional overcurrent protection, it's simultaneously used as an on-off switch.

Shunt Trip

The shunt trip is designed for controlling two separate loads with one assembly. The control is established by providing overload protection for the critical load. When the current through this load becomes excessive and reaches the trip point, the protector will open and remove power from both loads simultaneously. The total current rating of both loads must not exceed the maximum contact rating.

Dual Coil

By combining two electrically independent coils on a common magnetic circuit, it is possible to provide contact opening when either an over-current or trip voltage is applied to the respective coils. One coil will be a current trip coil with standard specifications. The second, or dual coil, can be used to provide a control function permitting contact opening from a remote interlock or other transducer functions. Standard coils are 6, 12, 24, 48, 120 and 240 volts. Tripping is instantaneous and must be removed (usually self-interrupting) after trip.

Auxiliary Switch (Applies to Series Trip Only)

This is furnished as an integral part of a series pole in single or multi-pole assemblies. Isolated electrically from the protector's circuit, the switch works in unison with the power contacts and provides indication at a remote location of the protector's on-off status.

Auxiliary switch contacts actuate simultaneously with the main breaker contacts, and will open regardless of whether the breaker contacts are opened manually or electrically. For auxiliary switch ratings below 6Vac or 5Vdc, an auxiliary switch with gold contacts, designated as REG is available. Gold contacts are not recommended for load current above 100 milliamps.

Note:

- A** Terminal protrusion dimensions are referenced from back of mounting panel.
- B** Each screw terminal is supplied with a 10-32x.312[7.92] or M5 x 8mm screw, flatwasher and external tooth lockwasher.
- C** Stud terminals are supplied with a flatwasher, external tooth lock washer and a 10-32 or M5 hex nut (<=70A), 1/4-20 or M6 hex nut (>70A).

Series and Switch Only

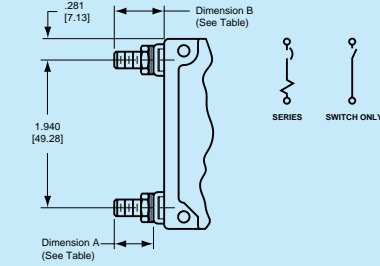

Series with Auxiliary Switch

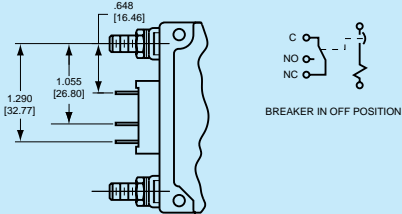

M6	.510	.652
1/4 - 20	.545	.687
M5	.510	.652
10 - 32	.545	.687
Screw stud thread	Dim. "A" (± .045)	Dim. "B" (± .035)

Note: Each outer terminal is supplied with a flatwasher, tooth lockwasher and a hex nut.

Shunt and Dual Coil

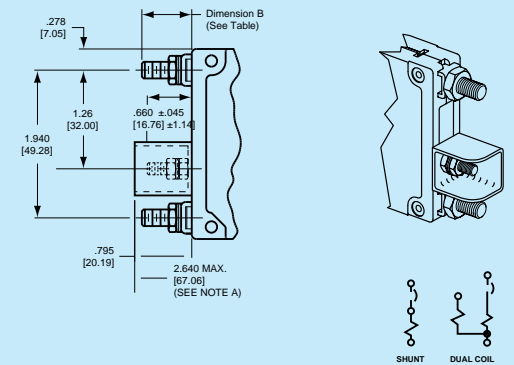

Spacing for VDE Switch

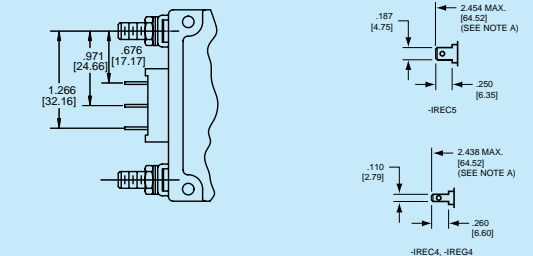

IAL/IUL/IEL CONFIGURATIONS (CONT'D)

Relay Trip

This permits the overload sensing coil to be placed in a circuit which is electrically isolated from the trip contacts. The coil may be actuated by sensors monitoring pressure, flow, temperature, speed, etc. Other typical applications include crowbar, interlock and emergency/rapid shutdown circuitry. Trip may be accomplished by voltage or current, which must be removed after trip.

Voltage Trip

Sometimes called "dump circuits" or "panic trip circuits," these units make it possible to open main power contacts with lower power inputs from one or more sources. This configuration is becoming increasingly more important for sensitive circuitry and denser packaging in automation systems. Available in series, shunt or relay configurations.

Relay and Dual Coil

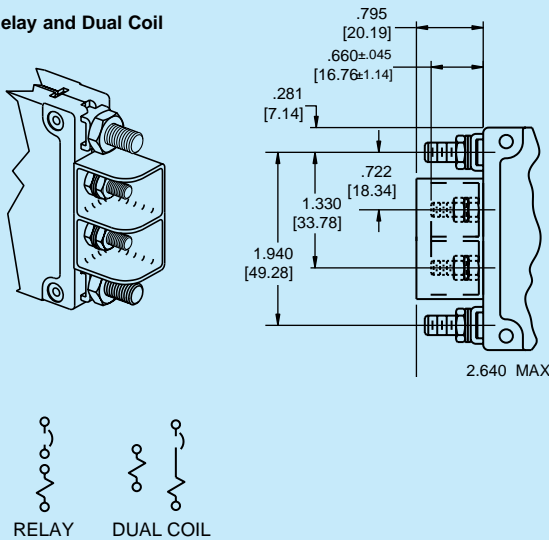

Notes:

- Tolerance ± .015 [.39] unless noted. Dimensions in brackets [] are millimeters.
- A** Terminal protrusion dimensions are referenced from back of mounting panel.
- B** Each screw terminal is supplied with a 10-32x.312[7.92] or M5 x 8mm screw, flatwasher and external tooth lockwasher.
- C** Stud terminals are supplied with a flatwasher, external tooth lockwasher and a 10-32 or M5 hex nut (<=70A), 1/4 -20 or M6 hex nut (>70A).

Barriers

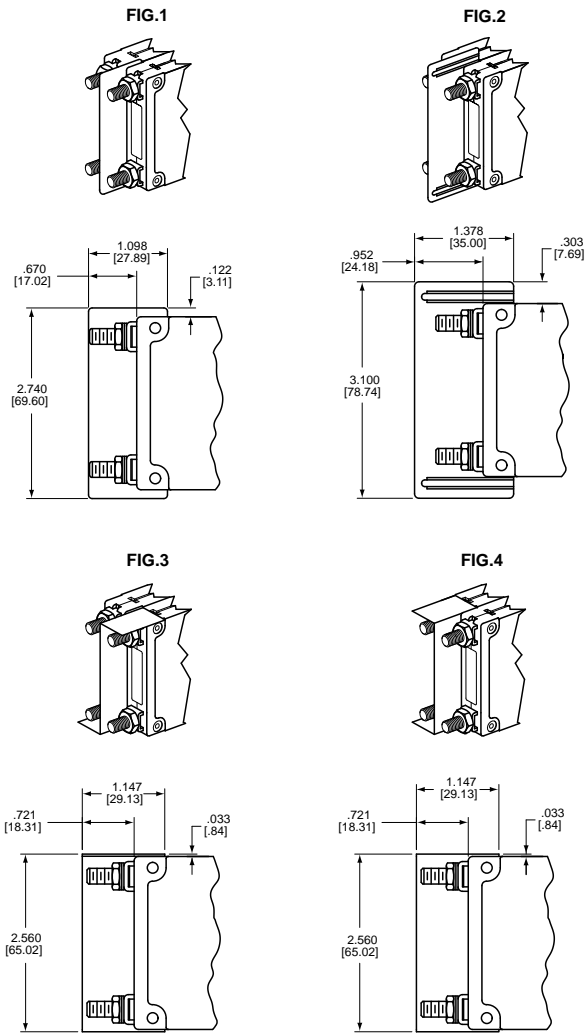

NOTE:
THIS BARRIER CAN BE FLIPPED TO COVER EITHER POLE.
PLEASE CONTACT FACTORY FOR SPECIFIC PART NUMBER

Rating Option	Standard Barrier	Optional Barrier
IEL		
240/415Vac	Fig. 1	Fig. 2,3 & 4
415V (VDE)		
277/480Vac		
1/4-20, M6 studs for AC		
120/240Vac multi-pole	Fig. 2	Fig. 3 & 4
125Vdc		
LEL		
All multi-pole 50/60Hz	Fig. 2	Fig. 3 & 4
All multi-pole 80Vdc if opposite polarity	Fig. 2	Fig. 3 & 4
125Vdc	Fig. 2	Fig. 3 & 4

Note: Optional barrier available with factory assigned part number. Contact factory for assistance.

Mid-Trip Indication

Circuit protection, rapid fault location and alarm capability are blended together in the Airpax mid-trip indication option. This option is designed for automatic handle movement to a middle position upon electrical overload, allowing for easier detection of the fault circuit and minimizing downtime due to the overload condition.

In the optional auxiliary switch configuration, the switch allows an alarm or signal to be forwarded when the breaker trips and the handle moves to the middle position. The alarm can be disengaged by the manual actuation of the handle to the OFF position. Once the fault has been corrected, the circuit breaker can be reset to the ON position. The mid-trip option is available in one, two or three pole toggle handle packages and in either standard panel screw or snap-in mounting. Please see specification tables of specific product for available ratings.

Snap-In Mounting

The snap-in mounting adapter allows for simplified mounting of most IEL/LEL toggle handle products. Prior to shipment, the adapter is attached to the circuit breaker during our final product assembly, allowing you to securely snap the unit into a rectangular panel cut-out. This eliminates the need for panel mounting hardware and associated assembly costs.

Available for units up to three poles, with or without an option handle guard.

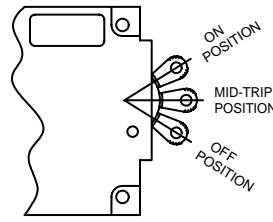

Mid-Trip Handle Positions

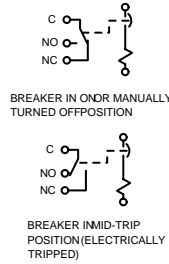

Panel Mounting Detail

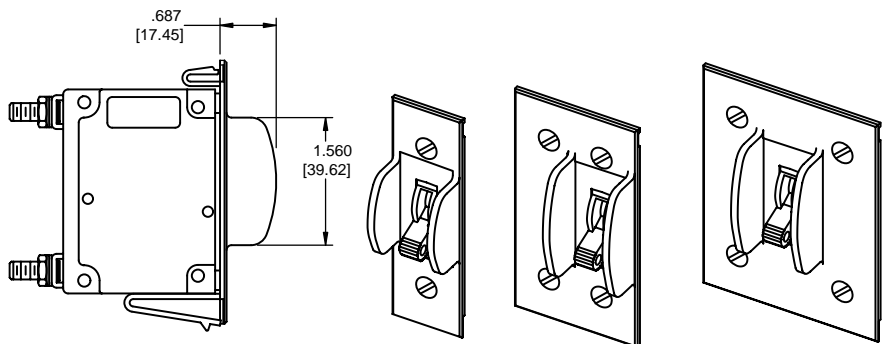
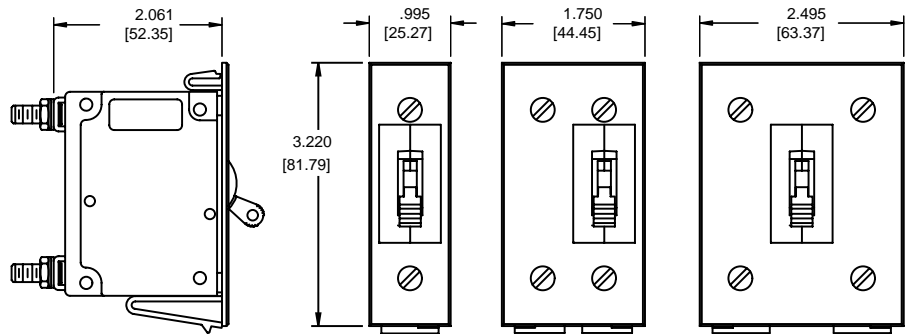
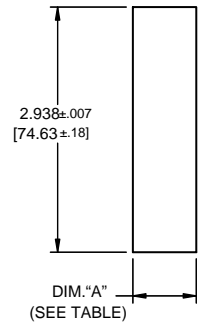

Panel Mounting Options

Number of Poles	Dimension \bar{A}
1 pole	.760 ± .007
2 pole	1.530 ± .007
3 pole	2.280 ± .007

Panel Thickness
.062 ± .005 [1.57 ± .13]

Note: Tolerance ± .015 [.39] unless noted. Dimensions in brackets [] are millimeters.

IAI/UL/LEL

ROCB REMOTE OPERATED CIRCUIT BREAKER

The Airpax Remote Operated Circuit Breaker (ROCB) provides the convenience of remote power disconnect and reset capability with the safety and accuracy of a magnetic current sensing device. It allows the operation of the circuit breaker from various locations in the system, facility or site, while not sacrificing the ability to manually operate the breaker if required. Service, diagnostics, load shedding and power distribution control functions can now be performed in areas that were previously unattended, inaccessible or unsafe.

Based on our popular IEL/LEL circuit protector series, the ROCB shares the same dimensional characteristics (maximum three poles plus the remote operator) for easy adaptation into existing panel designs, yet its compact size allows efficient use of space for new design applications. In addition, the ROCB has been designed to meet the requirements of domestic and international agency standards for motor operated circuit protection, ensuring worldwide component acceptance.

Contact Airpax for specific part number.

Note: Stud terminal style shown.

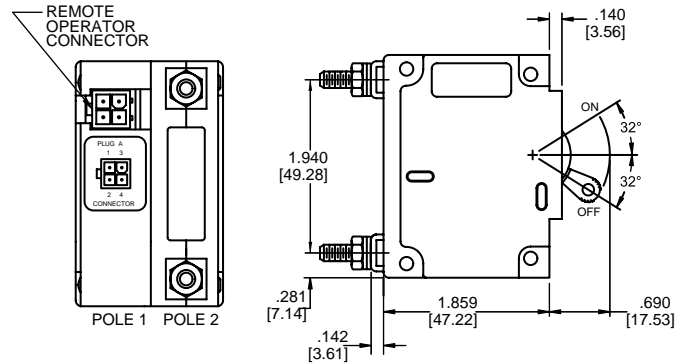

Single Pole

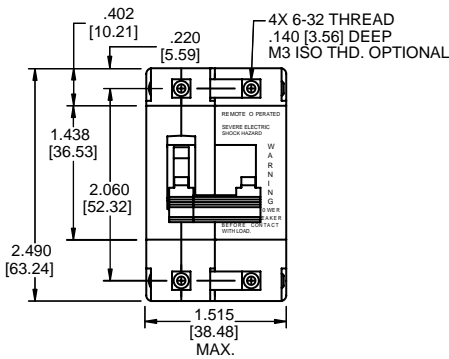

Two Pole

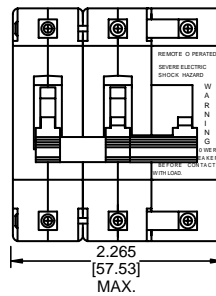

Three Pole

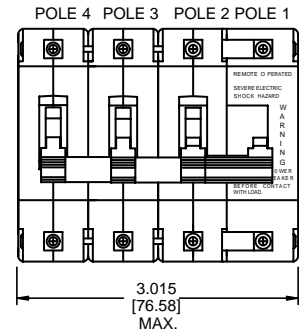

Panel Mounting Details Single Pole

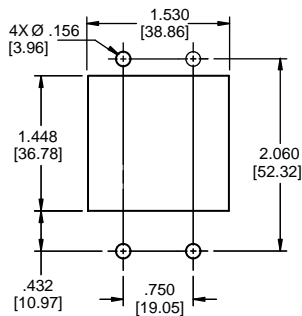

Two Pole*

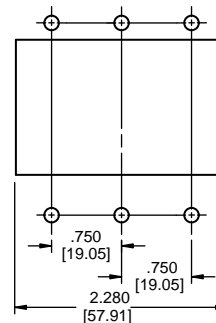

Three Pole*

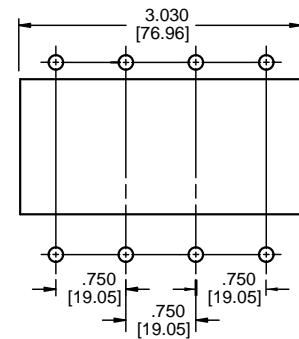

Remote Operator Module Specifications

Continuous Input Voltage: 80 Vdc Max., 20 Vdc Min.

Input Ripple Range: 20 Vdc peak to 80 Vdc peak

Maximum Current: Start-up: 1.00 A, Running: 0.30 A

Transit Time: Less than 2 seconds

Endurance: 4,000 operations min.

Dielectric Strength: 1,500 Vac between connector pins and grounded metal. Caution should be taken during dielectric testing. High voltage should not be applied between connector pins.

*See single pole mounting detail for hole sizes and locations.

Panel Mounting Detail:

Tolerance ±.005 [.13] Unless noted.

Note: Use Amp connector part numbers 172167-1 (housing), and 770988-1/171639-1 (pins). Not supplied.

Typical Protector Resistance/Impedance

Current ratings in amperes	DC Resistance - Ohms	50/60Hz Impedance - Ohms	400Hz* Impedance - Ohms
	51, 52, 53, 59	61, 62, 63, 69	41, 42, 43, 49
.200	45.8	28.5	71.94
1.0	1.38	1.10	2.85
2.0	.371	.29	.76
5.0	.055	0.51	.12
10.0	.017	.016	.032
20.0	.006	.006	.010
30.0	.003	.004	.006
50.0	.0019	.0018	.006
60.0	.00142	.00121	
70.0	.00138	.00118	
80.0	.00133	.00112	
90.0	.00127	.00107	
100.0	.00127	.00107	
125.0**	.0005		
150.0**	.0005		
165.0	.0004		
175.0**	.0004		
200.0**	.0004		

Notes: DCR and Impedance based on 100% rated current applied and stabilized for a minimum of one hour. Tolerance .05-2.5 amperes ± 20%; 2.6 - 20 amperes ± 25%; 21-200 amperes ± 50%. Consult factory for special values and for coil impedance of delays not shown.

Percentage Overload vs Trip Time in Seconds

Delay	100%	125%	150%	200%	400%	600%	800%	1000%
41*	No trip	May trip	.5 - 8	.15 - 1.9	.02 - .4	.006 - .25	.004 - .1	.004 - .05
42*	No trip	May trip	5 - 70	2.2 - 25	.40 - 5	.012 - 2	.006 - .2	.006 - .15
43*	No trip	May trip	35 - 350	12 - 20	1.5 - 20	.012 - 2.2	.01 - .22	.01 - .1
49*	No trip	May trip	.100 max.	.050 max.	.020 max.	.020 max.	.020 max.	.020 max.
51	No trip	.5-6.5	.3 - 3	.1- 1.2	.031 - 5	.011 - .25	.004 - .1	.004 - .08
52	No trip	2-60	1.8 - 30	1 - 10	.15 - 2	.04 - 1	.008 - .5	.006 - .1
53***	No trip	80 - 700	40 - 400	15 - 150	2 - 20	.23 - 9	.018 - .55	.012 - .2
59	No trip	.120 max.	.100 max.	.050 max.	.022 max.	.017 max.	.017 max.	.017 max.
61	No trip	.7 - 12	.35 - 7	.130 - 3	.030 - 1	.015 - .3	.01 - .15	.008 - .1
62	No trip	10-120	6 - 60	2 - 20	.2 - 3	.02 - 2	.015 - .8	.01 - .25
63	No trip	50-700	30 - 400	10 - 150	1.5 - 20	.4 - 10	.013 - .85	.013 - .5
69	No trip	.120 max	.100 max.	.050 max.	.022 max.	.017 max.	.017 max.	.017 max

* Available only in IAL/IUL/IEL; not available in LEL.

** LELHP current ratings, DC only.

*** Not available in LELHP.

IEL/IUL/IAL/LEL DELAY CURVES

400Hz, DC, 50/60Hz Delay Curves (typ)

A choice of delays is offered for DC, 50/60Hz, 400Hz, or combined DC/50/60Hz applications. Delays 49, 59, 69 and 79 provide fast-acting, instantaneous tripping and are often used to protect sensitive electronic equipment (not recommended where a known inrush exists). Delays 41, 51, 61 and 71 have a short delay for general purpose applications. Delays 42, 52, 62 and 72 are long enough for most transformers and capacitor loads. Delays 43, 53, 63 and 73 are extra long for special motor applications.

Inrush Pulse Tolerance

The table on page 139 provides a comparison of inrush pulse tolerance with and without the inertia delay feature for each of the 50/60Hz delays. Pulse tolerance is defined as a single pulse of half sine wave peak current amplitude of 8 milliseconds duration that will not trip the circuit breaker.

The table below provides a guide to determine if the inertia delay feature is required. Consult factory for further assistance.

Delay	Pulse Tolerance
61, 62, 63, 71, 72, 73	10 times (approx.) rated current
61F, 62F, 63F, 71F, 72F, 73F	12 times (approx.) rated current
64, 65, 66 (>80 - 100A)	25 times (approx.) rated current
64, 65, 66 (>50 - 80A)	20 times (approx.) rated current
64, 65, 66 (>80 - 100A)	18 times (approx.) rated current

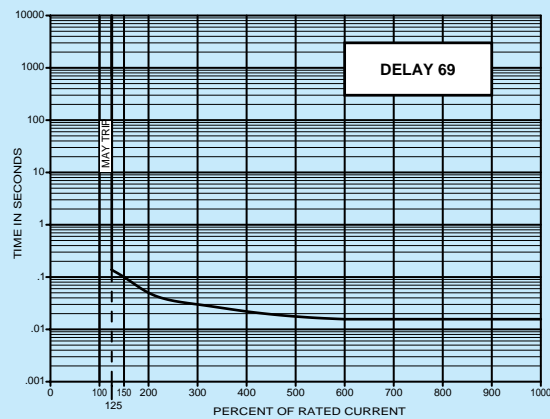
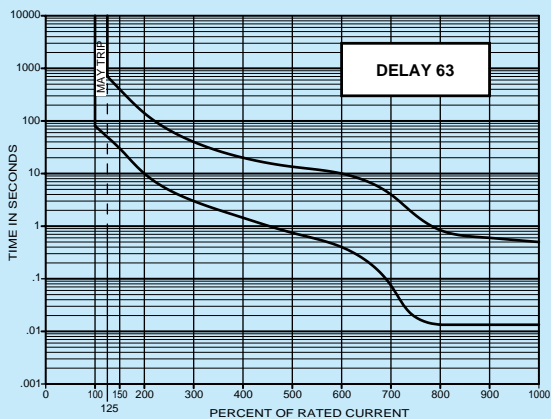
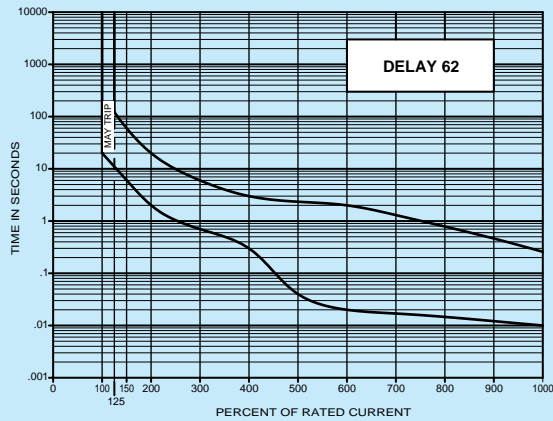
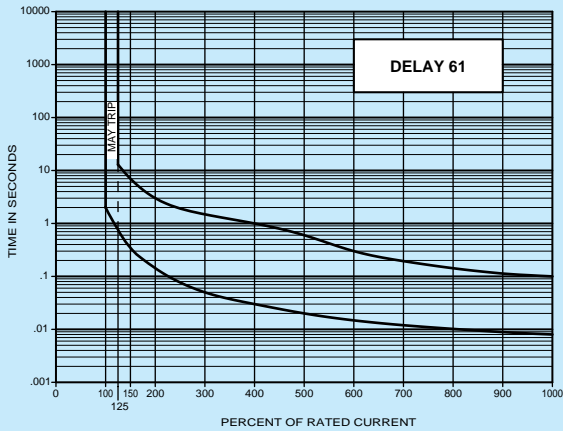

IEL/IUL/IAL/LEL

DC Delay Curves (typ)

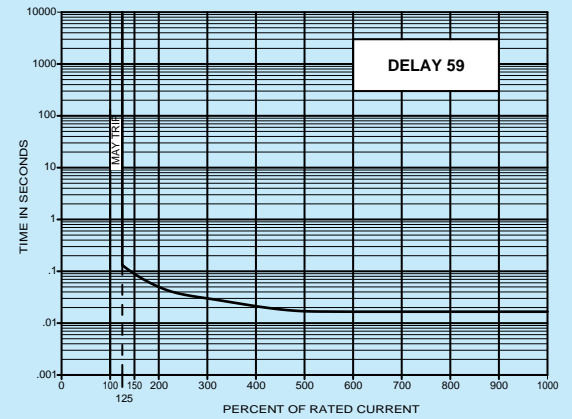
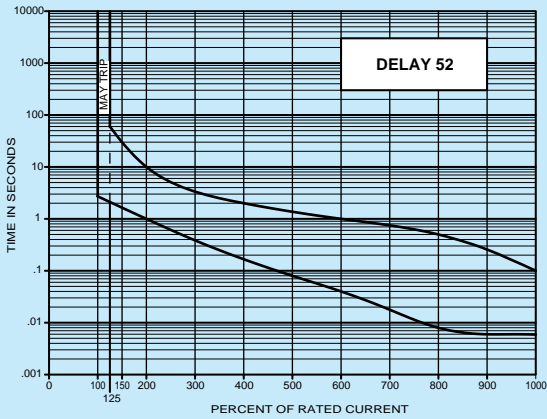
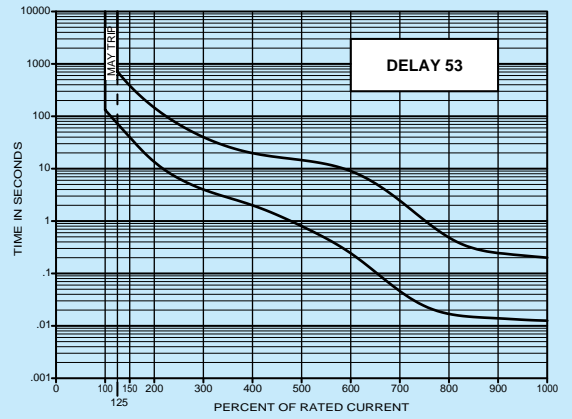
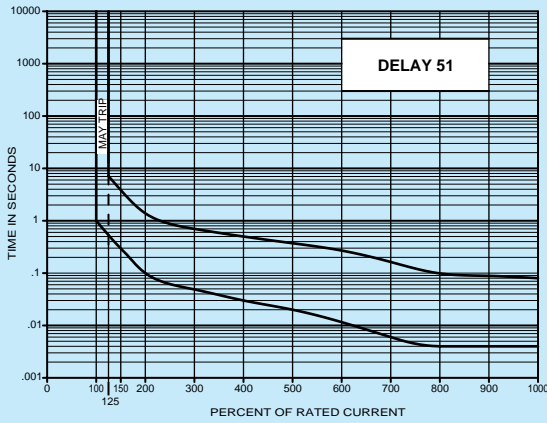

IAL/IUL/IEL/LEL

IAL/IUL/IEL DELAY CURVES

400Hz Delay Curves (typ)

*Available only in IAL/IUL/IEL; not available in LEL.

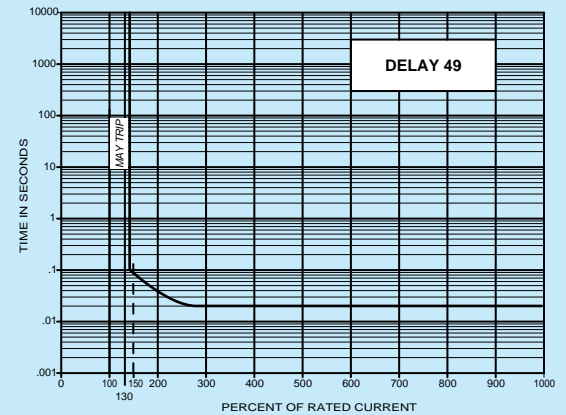
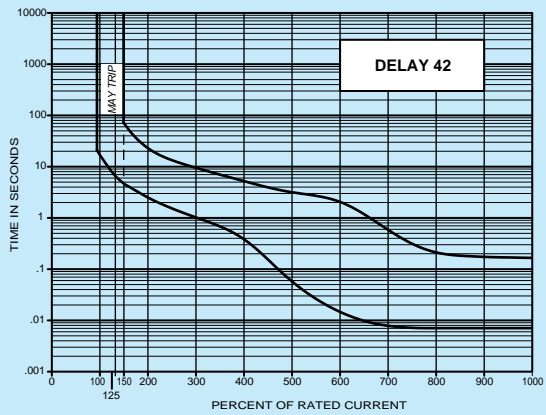
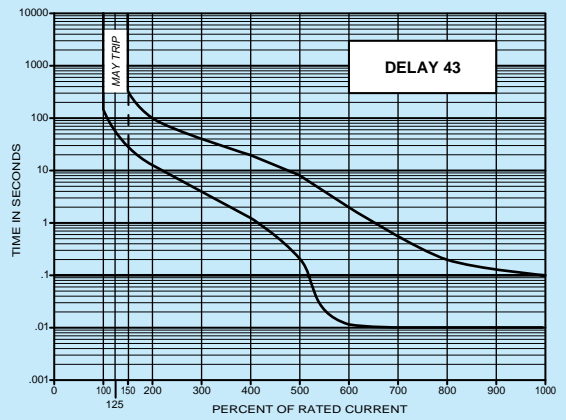
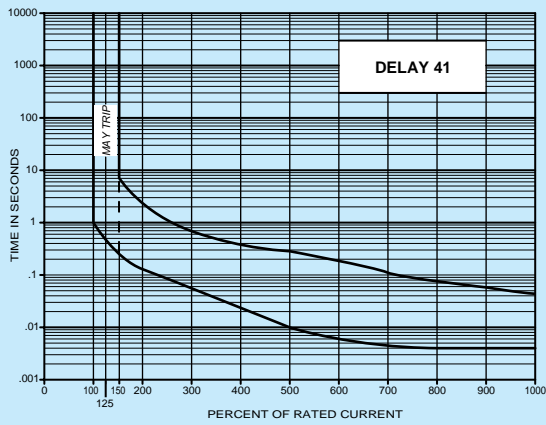

IAL/IUL/IEL/LEL

DC/50/60Hz Dual-frequency Delay Curves (typ)

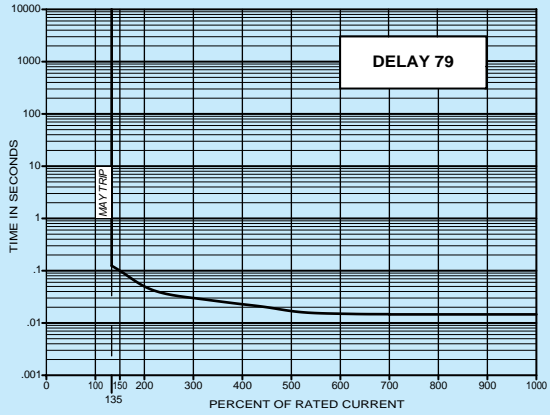
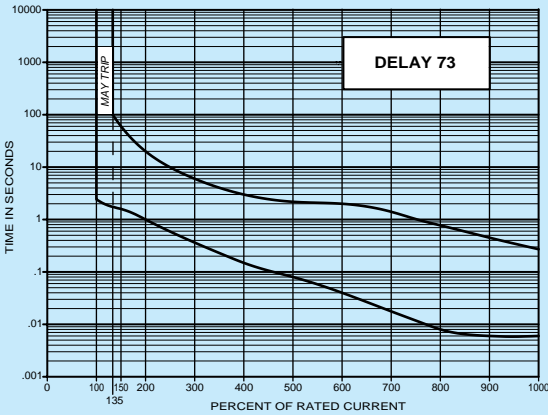
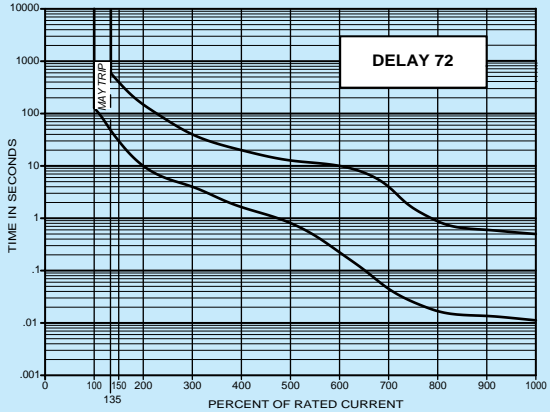
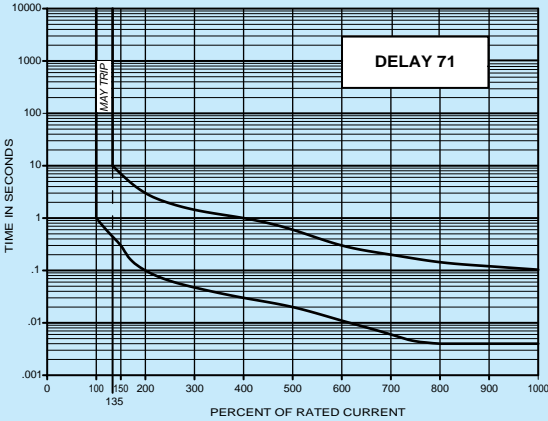

IAL/IUL/IEL

IAL/IUL/IEL/IDL/LEL SPECIFICATIONS

Trip Free

Will trip open on overload even when forcibly held in the ON position. This prevents the operator from damaging the circuit by holding the breaker on.

Trip Indication

The operating handle moves positively to the OFF or mid-trip position on electrical overload.

Ambient Operation

IAL/IUL/IEL protectors operate in temperatures between -40°C to $+85^{\circ}\text{C}$.

Insulation Resistance

Not less than 100 megohms at 500 volts DC.

Dielectric Strength

IAL/IUL/IEL protectors withstand 3750Vac (1250Vac for LEL), 60Hz for 60 seconds between all electrically isolated terminals except auxiliary switch terminals shall withstand 600Vac, 60Hz for REG and REC types. Four terminal dual coil and relay construction (not offered in the LEL) will withstand 1500Vac.

Endurance

Operating as a switch, the operating life exceeds 10,000 operations, 6000 at rated load, 4000 without load, at a rate of 6 per minute.

Electrical Characteristics

.050-100 amperes 80Vdc, 240Vac Max., 240/415Vac at 50 amperes Max., 50/60Hz and 400Hz. Consult factory for specific product ratings.

Units rated for 240/415Vac and above 50 amperes are not suitable for across-the-line motor starting.

Poles

One through six poles available.

Construction

Series, shunt, relay dual coil and series with auxiliary switch available in various delays and combinations.

Auxiliary Switch

When supplied shall be S.P.D.T. configuration. Non VDE approved switches have a maximum UL rating of 10.0 amperes, 250 volts, 60Hz; 3.0 amperes, 50 volts DC (REC type) or 0.1 amperes, 125 volts, 60Hz (REG type).

VDE approved switches have a maximum UL rating of 10.0 amperes, 250 volts, 60Hz (REC type); or 0.1 amperes, 125 volts, 60Hz (REG type). The maximum VDE ratings are 1.0 amperes, 125 volts, 60Hz (REC type); 0.1 amperes, 125 volts, 60Hz (REG type).

Moisture Resistance

Meet all the requirements of MIL-PRF-55629 when tested in accordance with Method 106 of MIL-STD-202.

Salt Spray (Corrosion)

Meet the requirements of MIL-PRF-55629 when tested in accordance with Method 101 of MIL-STD-202.

Shock

Circuit protectors shall not trip when tested per MIL-STD-202, Method 213, Test Condition I with 100% rated current applied to delayed units and 80% rated current to instantaneous units.

Vibration

Circuit protectors shall not trip when vibrated per MIL-STD-202, Method 204, Test Condition A with 100% rated current applied to delayed units and 80% rated current to instantaneous units.

UL-1500 (Marine Ignition Protected)

The IDL/IDLH is approved for Marine Ignition Protection (series configuration only), covering ignition protected circuit breakers. This specification requires devices to be used in accordance with the requirements of U.S. Coast Guard and Fire Protection Standard for Pleasure and Commercial Motor Craft, ANSI/MFPA #302.

Recommended Torque Specifications

6-32 mounting inserts	6 - 8 inch pounds
M3 mounting inserts	4 - 5 inch pounds
10 - 32 screw terminals	14 - 15 inch pounds
M5 screw terminals	14 - 15 inch pounds
10 - 32 stud terminals	13 - 14 inch pounds
M5 stud terminals	13 - 14 inch pounds
¼ - 20 stud terminals	40 - 45 inch pounds
M6 studs	40 - 45 inch pounds

Note: When applicable, mechanical support must be provided to terminals when applying torque.

Approximate Weight Per Pole

Ounces	Grams
3.1	90

Agency Approvals

		Current (A)		Short Circuit Current Rating (SC)					
IAL/IUL/IEL SUPPLEMENTARY PROTECTORS									
Voltage	Frequency (Hz)	Phase	Min. Poles	TC	OL	UL/CSA	VDE	UL 1077 & CSA	VDE
65	DC	-	1	1	1	.02-100	.10-70	U2, 7500	4000
65(4)	DC	-	1	1	1	.02-100	-	U2, 3000	-
65(4)	DC	-	1	1	1	.02-50	-	C1, 5000	-
65	DC	-	2**	2	1	101-150	-	U2, 7500	-
80	DC	-	1	1	1	.02-70	.10-50	U2, 7500	4000
80	DC	-	1	1	1	70.1-100	-	U2, 5000	-
80	DC	-	2	1	1	101-150	-	U1, 10000	-
80	DC	-	3	1	0	251-300	-	U2, 7500	-
125	DC	-	2	1	0	.02-100	-	U2, 5000	-
250	DC	-	2+	1	0	.02-50	-	U1, 5000	-
300	DC	-	3++	1	0	.02-50	.10-50	U2, 1000	5000
125	50/60	1	1	1	0	.02-70	-	U2, 5000	-
125	50/60	1	1	1	1	.02-100	-	U1, 3000	-
125(5)	50/60	1	1	1	1	.02-100	-	U3, 1500	-
120/240	50/60	1	2	2	1	.02-100	-	U1, 2000	-
125/250(5)	50/60	1	2 only	1	1	.02-100	-	U3, 1500	-
240	50/60	1&3	1	1	0	.02-70	-	U1, 2000	-
240	50/60	3	2	1	1	.02-100	-	U2, 2000	-
250	50/60	3	1	1	1	.02-50	.10-100	U2, 3000	2000
250	50/60	3	1	1	1	.02-50	.10-100	C2, 5000(1)	2000
250	50/60	1	1	1	1	.02-50	.10-100	C2, 5000(2)	2000
250	50/60	3	2	1	0	.02-80	.10-100	U1, 1000	2000
250	50/60	3	1	1	0	.02-60	.10-100	U1, 5000	2000
250(5)	50/60	3	3 only	1	1	.02-100	-	U3, 2000	-
277	50/60	1	1	1	1	.02-50	-	U2, 2000	-
277	50/60	1&3	1	2	1	.02-50	-	C2, 5000(1)	-
240/415	50/60	3	2	2	0	.02-50	.10-50	U2, 2000	2000
240/415	50/60	1	2	2	0	.02-50	.10-50	C2, 5000(1)	2000
277/480	50/60	3	2	2	1	.02-30	-	U2, 2000	-
277/480	50/60	3	2	2	1	.02-50	-	U2, 1200	-
277/480	50/60	3	2	1	1	.02-30	-	C2, 5000(3)	-
277/480	50/60	1&3	2	1	0	.02-50	-	C2, 5000(3)	-
480	50/60	1&3	2	1	1	.02-30	-	C2, 5000(3)	-
480	50/60	3	2	1	0	.02-50	-	C2, 5000(3)	-
250	400	1&3	1	2	1	.02-50	-	U2, 1500	-

Agency Approvals

		Current (A)		Short Circuit Current Rating (SC)			
LEL CIRCUIT BREAKERS							
Voltage	Frequency (Hz)	Phase	Min. Poles	UL/CSA	VDE	UL489	VDE
65	DC	-	1	.05-50	-	7500	-
65	DC	-	2**	101-150	-	50 000	-
65	DC	-	3**	175-200	-	50000	-
80	DC	-	1	.05-100	.10-100	10000	2000
80	DC	-	1	.05-100	-	50000	-
80	DC	-	2**	125-150	125-150	10000	2000
80	DC	-	3**	175-200	151-200	10000	2000
125	DC	-	1	.05-70	.05-50	5000	3000
125/250	DC	-	2	.05-50	-	5000	-
125	50/60	1&3	1	.05-40	-	10000	-
125	50/60	1&3	1	.05-50	.10-50	5000	2000
120/240	50/60	1	2	.05-70	.10-50	5000	2000
240	50/60	1&3	1	.05-20	-	5000	-
CEL/CELP COMMUNICATIONS EQUIPMENT CIRCUIT BREAKERS							
Voltage	Frequency (Hz)	Phase	Min. Poles	UL/CSA	VDE	UL 489A	VDE
65	DC	-	1	.05-50	-	7500	-
65	DC	-	2**	101-150	-	50000	-
80	DC	-	1	.05-100	-	50000	-
80	DC	-	2**	101-200	-	10000	-
80	DC	-	3**	201-250	-	10000	-
125	DC	-	1	.05-70	-	5000	-

Agency Approvals

		Current (A)		Short Circuit Current Rating (SC)					
IDL/IDL P SUPPLEMENTARY PROTECTORS (MARINE)									
Voltage	Frequency (Hz)	Phase	Min. Poles	TC	OL	UL/CSA	VDE	UL 1077 & CSA	VDE
48	DC	-	1	1	1	.02-100	-	U1, 5000	-
48	DC	-	2**	1	1	101-150	-	U1, 5000	-
65	DC	-	1	1	1	.02-60	-	U1, 1000	-
80	DC	-	1	1	1	.02-100	-	U2, 1500	-
125	50/60	1	1	1	1	.02-100	-	U1, 1500	-
250	50/60	1	2	1	1	.02-100	-	U2, 1500	-
250	50/60	1&3	1	1	1	.02-60	-	U1, 1000	-
IULQ SUPPLEMENTARY PROTECTORS (TAPPED COIL)									
Voltage	Frequency (Hz)	Phase	Min. Poles	TC	OL	UL/CSA	VDE	UL 1077 & CSA	VDE
125/250	50/60	1	1	1	1	2/1-30/15	-	C2, 5000(1)	-
IULD SUPPLEMENTARY PROTECTORS (DUST SEALED)									
Voltage	Frequency (Hz)	Phase	Min. Poles	TC	OL	UL/CSA	VDE	UL 1077 & CSA	VDE
250	50/60	1&3	1	1	1	.02-100	-	C2, 5000(3)	-
277	50/60	1	1	1	1	.02-30	-	C2, 5000(3)	-
Notes:									
** Paralleled poles; + 2 poles in series; ++ 3 poles in series; (1) With 125 A max. series fuse; (2) Series combination with 209 or 229 series (100 A max.); (3) With 100 A max. series fuse; (4) With blocked vent construction (5) Non-standard construction. "Fit for further use" approval									

General notes:

- All supplementary protectors are of the overcurrent (OC) type
- The family of protectors has been evaluated for end use application for use groups (UG) A, B, C and D
- The terminals (FW) are suitable for factory wiring only (0)
- The maximum voltage ratings for which the protectors have been tested are shown in the chart
- The current is the amperage range that the protectors have been tested
- The tripping current (TC) for all of the protectors is either either "1" (in the range of 125% to 135% of ampere rating) or "2" (more than 135% of ampere rating)
- The overload rating (OL) – designates whether the protector has been tested for general use or motor starting applications.
 - 0 – tested at 1.5 times amp rating for general use
 - 1 – tested at 6 times AC rating or 10 times DC rating for motor starting
- The short circuit current rating (SC) – The short circuit rating in amperes following a letter and number designating the test conditions and any calibration following the short circuit test is defined below:
 - C – Indicates short circuit test was conducted with series overcurrent protection
 - U – Indicates short circuit test was conducted without series overcurrent protection
 - 1 – Indicates a calibration was not conducted as part of the short circuit testing
 - 2 – Indicates a calibration was performed as part of the short circuit testing
 - 3 – Indicates recalibration was performed along with the dielectric and voltage withstand for "Suitable for Further Use" rating

How to Order

The ordering code for IAL/IUL/IEL/LEL circuit protectors may be determined by following the decision steps in the appropriate part number decision table subsequent to this page.

The coding given permits a self-assigning part number but with certain limitations. Special applications may require a factory assigned part number. Typical examples are units with mixed ratings, combinations of styles, or constructions not listed in the third decision table, etc. With these, it is suggested that order entry be by description and/or drawings, and a part number will be established. Additionally, it is standard policy to establish a factory-assigned part number whenever a descriptive drawing exists to provide cross reference, traceability and manufacturing control.

When specifying a circuit breaker for AC motor start or high inrush applications, the peak amplitude and surge duration should be specified for factory assistance in rating selection.

For example the code shown is the code for a single pole breaker with a series construction and auxiliary switch, designed for operation in a 50/60Hz circuit. It has a short time delay, rating of 20 amperes and a marked black handle, and is VDE approved.

To determine the ordering number for your particular IAL/IUL/IEL unit, simply follow the steps shown. You may use this number to place an order or as a reference for further questions you may have.

Notes:

IEL, IELH and IELX circuit protectors are designed to meet 8mm creepage clearance requirements for installation Category 111, Pollution Degree 3, Case A as measured in IEC 664. Intended for use in equipment to comply with IEC 950, 601 and VDE 0804 & 0805.

1 First Decision		
Select Type and Terminal		
Type	Description	Terminal
IAL **IUL ***IEL	One handle per unit	Standard screw terminal, no designation required
IALH **IULH ***IELH	One handle per pole	K Stud terminals
IALN **IULN ***IELN	One handle per unit panel seal	C Clip terminals
IALX **IULX ***IELX	One handle per unit, rocker, bracket mounting	B Bullet terminals
IALZX **IULZX ***IELZX	One handle per unit, rocker, integral mounting	
*IDL	One handle per unit UL 1500	
*IDLH	One handle per pole UL 1500	
***IML	One handle per unit mid trip indication	
***IMLH	One handle per pole mid trip indication	
IALBX **IULBX ***IELBX	One handle per unit, rocker, accidental-off protection	
**IMLBX	One handle per unit, mid trip indication, rocker, accidental-off protection	

*UL Recognized
**UL Recognized, CSA Certified
***UL Recognized, CSA Certified, VDE Approved

2 Second Decision	
Poles	
1	Single pole
11	Two pole
111	Three pole
1111	Four pole*

*Not available in toggle seal handle type. Consult factory for 5 and 6 pole IEL part number.

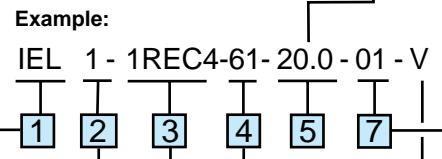

3 Third Decision	
Internal Configuration	
-0	Switch only
-1	Series
-1REC4	Series with auxiliary switch* .110 quick connect
-1REC5	Series with auxiliary switch* .187 quick connect
-1REG4	Series with auxiliary switch .110 quick connect
-1RS4	Series with alarm switch, electrical trip, .110 quick connect terminals
-1RLS4	Series with alarm switch, electrical trip, .110 quick connect terminals (mid-trip only)
-1RS5	Series with alarm switch, electrical trip, .187 quick connect terminals
-3	Shunt
-4	Relay (not available in IEL/IELX)

* Only one auxiliary switch is normally supplied on two or three pole units. Switch is located in the right-hand pole (viewed from terminal end) unless otherwise specified.

4 Fourth Decision	
Frequency & Delay	
SW	Switch only
-41	400Hz short delay
-42	400Hz long delay
-43	400Hz motor start
-49	400Hz 150% instant trip
-51	DC short delay
-52	DC long delay
-53	DC motor start
-59	DC 125% instant trip
-61	50/60Hz short delay
-62	50/60Hz long delay
-63	50/60Hz motor start
-69	50/60Hz 125% instant trip
-71	DC/60Hz short delay
-72	DC/60Hz long delay
-73	DC/60Hz motor start
-79	DC/60 Hz 135% instant trip

For addition of inertial delay, add an IFI to any delay numeral.

C = CCC Approved
This approval requires the addition of a C at the end of the part number. The unit will not be VDE Approved.
Note: CCC Approval is pending.

V = VDE and CCC Approved
The shaded areas denote VDE and CCC (if applicable) Approval options. This approval requires the addition of a V at the end of the part number. The V will be added to any part number formed entirely from shaded decisions. If non-shaded areas are selected, the unit will not be VDE or CCC Approved, but other approvals still apply.
Note: CCC Approval is pending.

IAL/IUL/IEL/LEL

5 Fifth Decision	
Rated Current	
Standard ratings listed. For other ratings, please contact the factory.	
.100	20.0
.250	30.0
.500	35.0
.750	40.0
1.00	50.0
2.50	60.0
5.00	70.0
7.50	80.0
10.0	90.0
15.0	100
Use three numbers to print required value between .050 amperes minimum and 100.0 amperes maximum. The VDE (Ith) will be 95% of the UL/CSA rated current.	

6 Sixth Decision	
Optional	
	Standard hardware. No designation required.
-A	Metric thread mounting inserts and terminals
-B	Barrier
-C	277V (50/60Hz only) (See note 3)
-D	240/415V (50/60Hz only)
-E	277V/480V (50/60Hz only) (See note 4)
-G	Handle guard, (available in ZX, BX and snap-in versions only)
-K	1/4 - 20 stud (M6 stud when -A option is selected) (70A requires -K, if >70A do not use -K)
-L	Handle lock
-M	Handle in opposite pole
-P	Snap-in face plate adapter
-T	80VDC
-U	120/240V 50/60Hz
-W	Wire clamp supplied (VDE approved up to and including 16.0 amps)
-X	Handle guard with no actuation feature (BX rocker only)
-1	Silver 5/16" (.312") bullet
-2	Gold 5/16" (.312") bullet
Notes: 1. One or more descriptions may be used as required. 2. When this is not used, table one may be substituted and U.S. thread and two lockwashers will be supplied. Unit will be rated at 250V (50/60Hz only). 3. VDE approved at 250Vac 4. VDE approved at 415Vac	

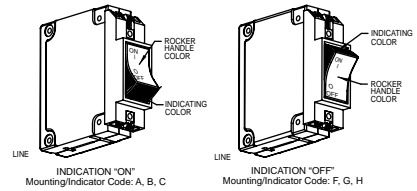

MARKING DETAIL "A" (SEE TABLE)

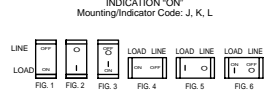
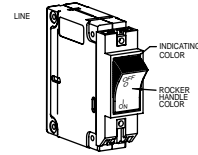

MARKING DETAIL "B" (SEE TABLE)

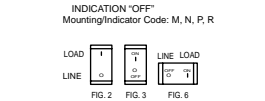
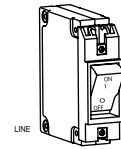

MARKING DETAIL "C" (SEE TABLE)

7 Seventh Decision		
Handle Color and Marking Selection		
IAL, IUL, IEL, IALH, IULH, IELH - Toggle Handle		
Color	Unmarked	Marked* ON-OFF I-O
Black	-00	-01 (STD)
Yellow	-10	-11
Red	-20	-21
Blue	-30	-31
Green	-40	-41
Orange	-60	-61
White	-90	-91

7 Seventh Decision											
Rocker Handle Color, Indicator Color and Marking Selection (See Notes)											
IALX, IULX, IELX, IALZX, IULZX, IELZX Rocker Handle (Single Rocker Color)											
Rocker Handle Color	Indicating Color	Marking Color	Indicates:	Unmarked	Vertical Mounting			Horizontal Mounting			Marking Detail
					On-Off Fig.1	I-O Fig.2	On-Off I-O Fig.3	On-Off Fig.4	I-O Fig.5	On-Off I-O Fig.6	
Black	N/A	White	N/A	-00	-01	-02	-03	-04	-05	-06	A
Red	N/A	White	N/A	-20	-21	-22	-23	-24	-25	-26	
Grey	N/A	Black	N/A	-40	-41	-42	-43	-44	-45	-46	
Orange	N/A	Black	N/A	-50	-51	-52	-53	-54	-55	-56	
White	N/A	Black	N/A	-90	-91	-92	-93	-94	-95	-96	
IALZX, IULZX, IELZX Rocker Handle (Dual Rocker Color)											
Black	White	White	On	-A0	-A1	-A2	-A3	-A4	-A5	-A6	A
Black	Red	White	On	-B0	-B1	-B2	-B3	-B4	-B5	-B6	
Black	Green	White	On	-C0	-C1	-C2	-C3	-C4	-C5	-C6	
Black	White	White	Off	-F0	-F1	-F2	-F3	-F4	-F5	-F6	
Black	Red	White	Off	-G0	-G1	-G2	-G3	-G4	-G5	-G6	
Black	Green	White	Off	-H0	-H1	-H2	-H3	-H4	-H5	-H6	
Black	White	White	On	-J0	-J1	-J2	-J3	-J4	-J5	-J6	B
Black	Red	White	On	-K0	-K1	-K2	-K3	-K4	-K5	-K6	
Black	Green	White	On	-L0	-L1	-L2	-L3	-L4	-L5	-L6	
IALBX, IULBX, IELBX, LELBX Rocker Handle (Dual Rocker Color)											
Black	White	White	Off	-M0	N/A	-M2	-M3	N/A	N/A	-M6	C
Black	Red	Red	Off	-N0	N/A	-N2	-N3	N/A	N/A	-N6	
Black	Green	Green	Off	-P0	N/A	-P2	-P3	N/A	N/A	-P6	
Black	Yellow	Yellow	Off	-R0	N/A	-R2	-R3	N/A	N/A	-R6	
Notes: A. Bezels of IALX, IULX, IELX, IELBX are black. B. Consult factory for other marking options.											

LEL DECISION TABLES

1 First Decision		
Select Type and Terminal		
Type	Description	Terminal
LEL	One handle per unit	Standard screw terminal, no designation required
LELH	One handle per pole	K Stud terminals
LML	One handle per unit, mid-trip indication	C Clip terminals
LMLH	One handle per pole, mid-trip indication	B Bullet terminals
LELZX	One handle per unit, rocker, integral mounting	
LMLZX	One handle per unit, rocker, mid-trip indication, integral mounting	
LEL BX	One handle per unit, rocker, accidental-off protected	
LML BX	One handle per unit, rocker, mid-trip indication, accidental-off protected	

Note: Other options available, consult factory.

2 Second Decision	
Poles	
1	Single pole
11	Two pole
111	Three pole

3 Third Decision	
Internal Configuration	
-1	Series
-1REC4	Series with auxiliary switch .110 quick connect
-1REC5	Series with auxiliary switch .187 quick connect
-1REG4	Series with auxiliary switch (gold contacts) .110 quick connect
-1RS4	Series with alarm switch, electrical trip, .110 quick connect
-1RLS4	Series with alarm switch, electrical trip, .110 quick connect*

* Used only with mid-trip.

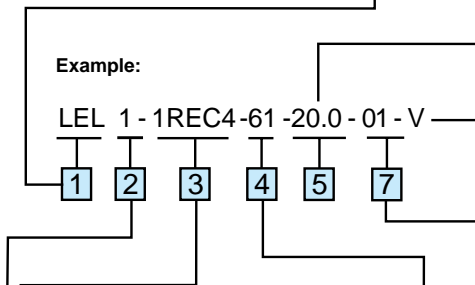

4 Fourth Decision	
Frequency and Delay	
-51	DC short delay
-52	DC long delay
-53*	DC motor start
-59	DC 125% instant trip
-61	50/60Hz short delay
-62	50/60Hz long delay
-63	50/60Hz motor start
-69	50/60Hz 125% instant trip

For addition of inertial delay, add an "F" to any delay numeral.
*Not available above 100 amps.

V = VDE and CCC Approved

The shaded areas denote VDE and CCC (if applicable) Approval options. This approval requires the addition of a V at the end of the part number. The V will be added to any part number formed entirely from shaded decisions. If non-shaded areas are selected, the unit will not be VDE or CCC Approved, but other approvals still apply.

C = CCC Approved

The approval requires the addition of a C at the end of the part number. The unit will not be VDE Approved.

5 Fifth Decision	
Rated Current	
Use three numbers to print. Required value between .050 amps minimum and 100 amps maximum.	

6 Sixth Decision	
Optional	
-A	Metric thread mounting inserts and terminals
-B	Barrier
-F	240V 50/60Hz
-G	Handle guard, (available in ZX, BX and snap-in versions only)
-K	1/4 - 20 Stud (M6 Stud when -A option is selected) (50A requires -K, >50A do not use -K)
-L	Handle Lock
-M	Handle in opposite pole
-P	Snap-in mounting plate adapter
-U	120/240Vac, 5000 A.I.C., 70A max. 2 pole only with barrier
-V	125VDC
-X	Handle guard with no actuate "off" feature (see detail C)
-1	Silver 5/16" (.312") bullet
-2	Gold 5/16" (.312") bullet

Notes:
1. One or more descriptions may be used as required.
2. When this decision is not used, decision 7 may be substituted and U.S. thread will be supplied.
3. If (M5 or M6) studs are required, use "A" only on an LELK.

7 Seventh Decision	
LEL Toggle Handle Color Selection	
-01	Black w/ white markings
-11	Yellow w/ black markings
-21	Red w/ white markings
-31	Blue w/ white markings
-41	Green w/ white markings
-61	Orange w/ black markings
-91	White w/ black markings

See alternate 7th Decision on page 151 for ZX and BX Rocker Handles.

Notes: The LEL family of circuit breakers are designed to meet 8mm creepage and clearance requirements for installation Category 111, pollution degree 3, Case A as measured in IEC 664. Intended for use in equipment designed to comply with IEC 380, 435, 601 AND VDE 0730, 0804 & 0805.

IA/UL/IE/LEL

7 Seventh Decision

Rocker Handle Color, Indicator Color and Marking Selection (See Notes)

LELZX & LMLZX Rocker Handle (Single Rocker Color)

Rocker Handle Color	Indicating Color	Marking Color	Indicates:	Unmarked	Vertical Mounting			Horizontal Mounting			Marking Detail
					On-Off Fig.1	I-O Fig.2	On-Off I-O Fig.3	On-Off Fig.4	I-O Fig.5	On-Off I-O Fig.6	
Black	N/A	White	N/A	-00	-01	-02	-03	-04	-05	-06	A
Red	N/A	White	N/A	-20	-21	-22	-23	-24	-25	-26	
Grey	N/A	Black	N/A	-40	-41	-42	-43	-44	-45	-46	
Orange	N/A	Black	N/A	-50	-51	-52	-53	-54	-55	-56	
White	N/A	Black	N/A	-90	-91	-92	-93	-94	-95	-96	

LELZX & LMLZX Rocker Handle (Dual Rocker Color)

Black	White	White	On	-A0	-A1	-A2	-A3	-A4	-A5	-A6	A
Black	Red	White	On	-B0	-B1	-B2	-B3	-B4	-B5	-B6	
Black	Green	White	On	-C0	-C1	-C2	-C3	-C4	-C5	-C6	
Black	White	White	Off	-F0	-F1	-F2	-F3	-F4	-F5	-F6	
Black	Red	White	Off	-G0	-G1	-G2	-G3	-G4	-G5	-G6	
Black	Green	White	Off	-H0	-H1	-H2	-H3	-H4	-H5	-H6	
Black	White	White	On	-J0	-J1	-J2	-J3	-J4	-J5	-J6	B
Black	Red	White	On	-K0	-K1	-K2	-K3	-K4	-K5	-K6	
Black	Green	White	On	-L0	-L1	-L2	-L3	-L4	-L5	-L6	

LELZX Rocker Handle (Dual Rocker Color)

Black	White	White	Off	-M0	N/A	-M2	-M3	N/A	N/A	-M6	C
Black	Red	Red	Off	-N0	N/A	-N2	-N3	N/A	N/A	-N6	
Black	Green	Green	Off	-P0	N/A	-P2	-P3	N/A	N/A	-P6	
Black	Yellow	Yellow	Off	-R0	N/A	-R2	-R3	N/A	N/A	-R6	

Notes: A. Bezels of IALBX, IULBX, IELB, IELBX are black.
 B. Consult factory for other marking options.

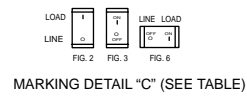
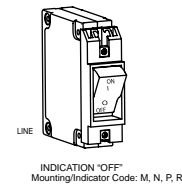
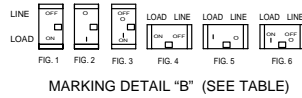
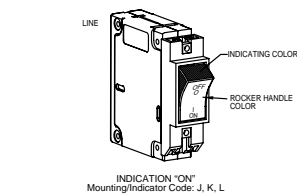
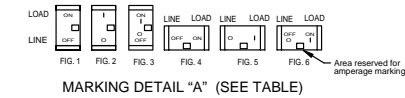
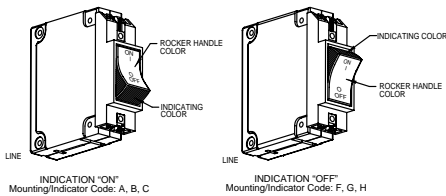

IAI/UL/LEL

1 First Decision	
Type	
LELPK*	One handle per unit
LMLPK*†	
LELZXP*	One ZX rocker handle per unit (integral mounting)
LMLZXP*†	
LELBXP*	One BX rocker handle per unit (integral mounting) accidental-off protected
LMLBXP*†	
LELHP*	One handle per pole
LMLHP*†	

* Stud Terminals
† Mid-Trip

Notes:
1. One toggle handle per unit is available on 125 amps to 150 amps units (two parallel pole construction.)
2. 175 amps to 200 amps (three parallel pole construction) require handles in each pole. "H" version First Decision.

3 Third Decision	
Internal Configuration	
-1	Series
-1REC4	Series with auxiliary switch .110 quick connect
-1REG4	Series with auxiliary switch (gold contacts) .110 quick connect
-1RS4	Series with alarm switch, electrical trip, .110 quick connect
-1RLSG4	Series with alarm switch, electrical trip, (gold contacts) .110 quick connect*
-1RLS4	Series with alarm switch, electrical trip, .110 quick connect*
-1REC5	Series with auxiliary switch .187 quick connect
-1RS5	Series with alarm switch, electrical trip, .187 quick connect
-1RLS5	Series with alarm switch, electrical trip, .187 quick connect*

* Used only with mid-trip.

5 Fifth Decision	
Rated Current (Amps)	
	125.
	130.
	135.
	150.
	175.
	200.

For other ratings, please consult factory.

6 Sixth Decision	
Optional	
-A	Metric thread mounting inserts and terminals
-G	Handle guard (available in ZX, BX and snap-in versions only)
-X	Handle guard with no actuate off feature (available in BX versions only)
-P	Snap-in mounting plate adapter

Notes:
1. One or more descriptions may be used as required.
2. When this decision is not used, decision 7 may be substituted and U.S. thread will be supplied.

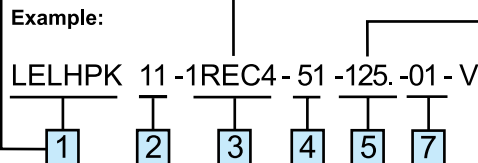

2 Second Decision	
Poles	
11	Two pole (up to 150 amps)
111	Three pole (160 to 200 amps)

4 Fourth Decision	
Frequency and Delay	
-51	DC short delay, 125% trip (125-150 amps)
	DC short delay, 135% trip (160-200 amps)
-52	DC long delay, 125% trip (125-150 amps)
	DC long delay, 135% trip (160-200 amps)
-59	DC 125% instant trip (125-150 amps)
	DC 135% instant trip (160-200 amps)

For addition of inertial delay, add an IFI to any delay numeral.

V = VDE Approved

The shaded areas denote VDE Approval options. This approval requires the addition of a V at the end of the part number. The V will be added to any part number formed entirely from shaded decisions. If non-shaded areas are selected, the unit will not be VDE Approved, but other approvals still apply.

7 Seventh Decision	
LELHPK Toggle Handle Color Selection	
-01	Black w/ white markings
-11	Yellow w/ black markings
-21	Red w/ white markings
-31	Blue w/ white markings
-41	Green w/ white markings
-61	Orange w/ black markings
-91	White w/ black markings

See alternate 7th Decision on page 151 for ZX and BX Rocker Handles.

IA/UJ/EL/LEL